

2016

LEVEL OF DEVELOPMENT SPECIFICATION

BIMFORUM

August 2016
Draft for Public Comment

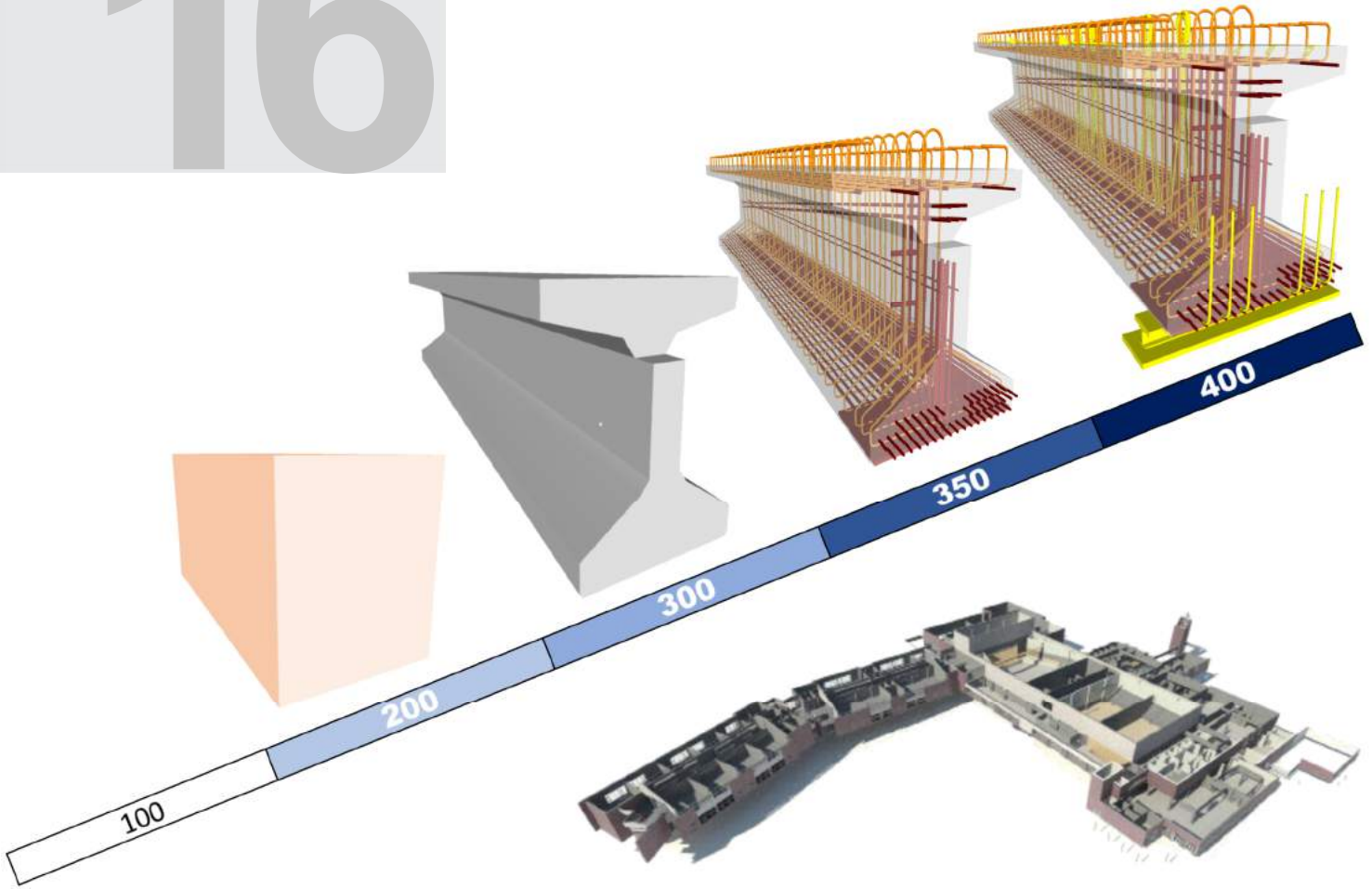

	Model Elements	Concept	SD	Milestone 1	DD	Permit	100% CD	Constr. Coord.	Fabrication
Architecture, Structure, MEP, Interiors, Site / Civil	xxxxxxx								
	xxxxxxx								
	xxxxxxx								
	xxxxxxx								
	xxxxxxx								
	xxxxxxx								
	xxxxxxx								

In collaboration with:

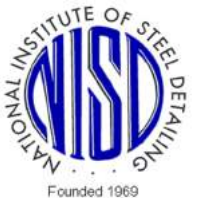

CD-BIM.com
Certificate of Development in
Building Information Modeling



Level of Development Specification

Version: 2016

August 25, 2016

For Building Information Models

Nothing contained in this work shall be considered to be the rendering of legal advice for specific cases, and readers are responsible for obtaining such advice from their own legal counsel. This work and any forms herein are intended solely for educational and informational purposes.

Level of Development Specification © 2015 by BIMForum. No portions of this work may be reproduced or displayed without the express written permission of the copyright holders. All rights reserved.

ACKNOWLEDGEMENTS

Many thanks to all the individuals and organizations who reviewed and contributed to this work, and to the following industry association representatives and co-chairs of the major discipline subgroups who made this document possible:

Overall co-chairs

Jan Reinhardt, Adept Project Delivery

Jim Bedrick, FAIA, AEC Process Engineering

Current Committee Co-Chairs

	Design	Construction
Structures	Will Ikerd, PE, LEED AP Ikerd Consulting	David Merrifield Steel Fab, Inc.
Exterior Skin	James Vandezande AIA, HOK	Walt Cichonski L F Driscoll
Interior Construction	Ron Dellaria, RA, CSI CannonDesign	Brian Filkins Mortenson
Building Services	Birgitta Foster VDCO Tech	David Francis Murray Company Aaron Lawson Morrow Meadows
Civil	Will Ikerd, PE, LEED AP Ikerd Consulting	Dan Russell, LEED AP, Sundt Construction, Inc.
Bridge: Highway & Rail	Will Ikerd, PE, LEED AP Ikerd Consulting	David Merrifield Steel Fab, Inc.

Industry association representatives

Dmitri Alferieff, Associated General Contractors

Michael Bomba, Esq., American Institute of Architects

Overall Editing and Graphics Creation

IKERD Consulting, LLC (IKERD.com)

Additional Contributors

In addition, we'd like to thank the many contributors from all sectors of the industry who helped make this specification possible, including:

Andy Jizba, US CAD
Benjamin Crosby, Yates Construction
Bill Klorman, Klorman Construction & ACI 131 BIM Committee Member (Concrete)
Brenda Ikerd, Ikerd Consulting (Structures, Civil)
Brian Skripac, Assoc. AIA, LEED AP BD+C, CannonDesign, AIA TAP KC
Chuck Eastman, Ph.D, Georgia Institute of Technology
David Merrifield, Steel Fab, Inc.
Eloisa Amaya, Ikerd Consulting (Graphics Editing, Structures, and Cover)
Jamie L. Davis, PE, LEED AP, Ryan Biggs | Clark Davis Engineering & Surveying (Masonry)
Jason P. Lien, PE, Precast Concrete Institute (PCI) BIM Committee, EnCon United (Precast)
Joe Cipra, Vulcraft/Verco Group (Structural Steel Open Web Joists and Metal Deck)
John Russo, AIA, President, US Institute of Building Documentation (Laser Scanning & Level Of Accuracy)
Kirk Capristo, Astorino (Cover)
Lee Garduno, Southland Industries (MEP)
Luke Faulkner, LEED AP, AISC (Structural Steel)
Matthew J. Gomez PE, SE, Gerdau (Structural Steel)
Michael Bolduc, PE (MA), Simpson Gumpertz & Heger (Structural)
Michael Gustafson, PE, Autodesk (Structural)
Michael Mulder, Southland Industries (MEP)
Murat Karakas, Arup (MEP)
Paul J. Hause, PE, Structural Consultants Inc. (Structural)
Peter J. Carrato, Ph.D., PE, SE, Bechtel & ACI 131 BIM Committee Chair (Concrete)
R. Wayne Muir, P.E., Structural Consultants Inc. & SEI-CASE BIM Committee Co-Chair (Structures)
Rebecca Stanford, Ikerd Consulting (Structures)
Roger Becker, PE, SE, Precast Concrete Institute (PCI) Managing Director of Research and Development (Precast)
Schaeffer Harris, EIT, Ikerd Consulting (MEP)
Scott Babin, ITW Building Components Group (Wood)
Soheil Seiqali, Klorman Construction (Concrete)
Steven Bumbalough, ITW Building Components Group (Wood)
Trevor Koller, EIT, Ikerd Consulting (Structural, Bridge)

CONTENTS

ACKNOWLEDGEMENTS.....	2
INTRODUCTION.....	10
1 Overview	10
1.1 Description.....	10
1.1.1 LODs and Design Phase.....	10
1.1.2 LODs and Model Definition.....	10
1.2 Intent.....	11
1.2.1 Not a set of Requirements.....	11
1.2.2 Complements a BIM Execution Plan (BIMXP).....	11
1.3 Background.....	11
1.3.1 AIA Effort.....	11
1.3.2 BIMForum Effort.....	11
1.3.3 LOD Definitions.....	11
2 Levels of Development.....	12
2.1 BIM as a Communication Tool.....	12
2.2 Level of Development vs. Level of Detail.....	12
2.3 Fundamental LOD Definitions.....	12
2.3.1 LOD 100.....	12
2.3.2 LOD 200.....	12
2.3.3 LOD 300.....	13
2.3.4 LOD 350.....	13
2.3.5 LOD 400.....	13
2.3.6 LOD 500.....	13
2.4 Example – Light Fixture:.....	13
3 Using the Specification.....	13
3.1 Glossary.....	13
3.1.1 Specific:.....	13
3.1.2 Actual:.....	13
3.2 Details.....	14
3.2.1 Order of Precedence.....	14
3.2.2 LOD Definitions as Minimum Requirements.....	14
3.2.3 LOD Definitions are Cumulative.....	14
3.2.4 Model Element Author.....	14
3.2.5 2D Supplementary Drawings.....	14
3.3 Project-Specific Information.....	14
3.3.1 Size Thresholds.....	14
3.3.2 Clearances.....	14
3.4 Using the Specification with a BIMXP.....	14
3.4.1 Reliance.....	15
3.4.2 Multiple uses.....	15
3.4.3 Efficient sequencing.....	15

3.4.4	Avoidance of over-modeling	15
3.5	Implementation of the Specification	15
3.5.1	Rely on the Model Element Table.....	15
3.5.2	Include LOD Designations as Attributes of Individual Model Elements	15
4	Organization of the Specification	15
4.1	Geometric and Attribute Information	15
4.1.1	Part I: Element Geometry	15
4.1.2	Part II: Associated Attribute Information	15
4.1.3	Model Element Table.....	16
4.1.4	Building Systems	16
4.1.5	Milestones/Deliverables.....	16
4.1.6	Attribute Tables	17
4.1.7	Attribute Table Anatomy	17
4.1.8	MEPF Attribute Tables.....	18
4.1.9	Using the Attribute Tables	18
5	Updates of This Document	19
5.1	Revision History	19
5.2	Revision Process	19
5.2.1	Public Comment	19
5.2.2	Appendix.....	19
PART I – ELEMENT GEOMETRY		20
A	21-01 SUBSTRUCTURE.....	20
A10	21-01 10 Foundations.....	20
A1010	21-01 10 10 Standard Foundations.....	20
A1010.90	21-01-10 10 90 Standard Foundation Supplementary Components TBD	26
A1020	21-01 10 20 Special Foundations.....	26
A1020.80	21-01 10 20 80 Grade Beams	27
A20	21-01 20 Subgrade Enclosures	29
A2010	21-01 20 10 Walls for Subgrade Enclosures	29
A40	21-01 40 Slabs-on-Grade	30
A4010	21-01 40 10 Standard Slabs-on-Grade	30
A4020	21-01 40 20 Structural Slabs-on-Grade.....	31
A4030	21-01-40-30 Slab Trenches TBD	33
A4040	21-01-40-40 Pits and Bases TBD.....	33
A4090	21-01-40-90 Slab-On-Grade Supplementary Components TBD	33
A60	21-01-60 Water and Gas Mitigation TBD	33
A6010	21-01-60-10 Building Subdrainage TBD.....	33
A6020	21-01-60-20 Off-Gassing Mitigation TBD	33
A90	21-01-90 Substructure Related Activities TBD.....	33
A9010	21-01-90-10 Substructure Excavation TBD.....	33
A9020	21-01-90-20 Construction Dewatering TBD	33
A9030	21-01-90-30 Excavation Support TBD.....	33

A9040	21-01-90-40 Soil Treatment TBD	33
B	21-02 00 00 SHELL.....	34
B10	21-02 10 Superstructure	34
B1010	21-02 10 10 Floor Construction	34
B1020	21-02 10 20 Roof Construction	58
B1080	21-02 10 80 Stairs.....	59
B20	21-02 20 Exterior Vertical Enclosures.....	66
B2010	21-02 20 10 Exterior Walls	66
B2010	21-02 20 10 Exterior Walls (Masonry).....	67
B2010	21-02 20 10 Exterior Walls (Cold-Form Metal Framing).....	69
B2010	21-02 20 10 Exterior Walls (Wood)	71
B2020	21-02 20 20 Exterior Windows	78
B2050	21-02 20 50 Exterior Doors and Grilles	83
B2070	Exterior Louvers and Vents	85
B2080	21-02 20 80 Exterior Wall Appurtenances.....	86
B2090	21-02 20 90 Exterior Wall Specialties	87
B30	21-02 30 Exterior Horizontal Enclosures.....	87
B3010	21-02 30 10 Roofing.....	87
B3020	21-02 30 20 Roof Appurtenances	88
B3040	21-02 30 40 Traffic Bearing Horizontal Enclosures	89
B3060	21-02 30 60 Horizontal Openings.....	90
B3080	21-02 30 80 Overhead Exterior Enclosures	91
C	21-03 INTERIORS.....	93
C10	21-03 10 Interior Construction.....	93
C1010	21-03 10 10 Interior Partitions	93
C1020	21-03 10 20 Interior Windows	103
C1030	21-03 10 30 Interior Doors	104
C1040	21-03 10 40 Interior Grilles and Gates	106
C1060	21-03 10 60 Raised Floor Construction.....	107
C1070	21-03 10 70 Suspended Ceiling Construction	108
C1090	21-03 10 90 Interior Specialties.....	109
C20	21-03 20 Interior Finishes	113
C2010	21-03 20 10 Wall Finishes.....	113
C2020	21-03 20 20 Interior Fabrications	114
C2030	21-03 20 30 Flooring	114
C2040	21-03 20 40 Stair Finishes	114
C2050	21-03 20 50 Ceiling Finishes.....	114
D	21-04 00 00 SERVICES.....	115
D10	21-04 10 Conveying.....	115
D1010	21-04 10 10 Vertical Conveying Systems.....	115
D1030	21-04 10 30 Horizontal Conveying	116
D1050	21-04 10 50 Material Handling	117

D1080	21-04 10 80 Operable Access Systems	120
D20	21-04 20 Plumbing.....	121
D2010	21-04 20 10 Domestic Water Distribution.....	121
D2020	21-04 20 20 Sanitary Drainage	126
D2030	21-04 20 30 Building Support Plumbing Systems	129
D2050	21-04 20 50 General Service Compressed-Air.....	134
D2060	21-04 20 60 Process Support Plumbing Systems	134
D30	21-04 30 Heating, Ventilation, and Air Conditioning (HVAC)	137
D3010	21-04 30 10 Facility Fuel Systems	137
3020	21-04 30 20 Heating Systems	140
D3030	21-04 30 30 Cooling Systems	143
D3050	21-04 30 50 Facility HVAC Distribution Systems	146
D3060	21-04 30 60 Ventilation	150
D3070	21-04 30 70 Special Purpose HVAC Systems	153
D40	21-04 40 Fire Protection	154
D4010	21-04 40 10 Fire Suppression	154
D4030	21-04 40 30 Fire Protection Specialties	157
D50	21-04 50 Electrical	158
D5010	21-04 50 10 Facility Power Generation	158
D5020	21-04 50 20 Electrical Service and Distribution.....	160
D5030	21-04 50 30 General Purpose Electrical Power	163
D5040	21-04 50 40 Lighting	165
D5080	21-04 50 80 Miscellaneous Electrical Systems	167
D60	21-04 60 Communications	168
D6010	21-04 60 10 Data Communications	168
D6020	21-04 60 20 Voice Communications	168
D6030	21-04 60 30 Audio-Video Communication.....	168
D6060	21-04 60 60 Distributed Communications and Monitoring.....	168
D6090	21-04 60 90 Communications Supplementary Components	168
D70	21-04 70 Electronic Safety and Security	169
D7010	21-04 70 10 Access Control and Intrusion Detection	169
D7030	21-04 70 30 Electronic Surveillance.....	169
D7050	21-04 70 50 Detection and Alarm.....	169
D7070	21-04 70 70 Electronic Monitoring and Control	169
D7090	21-04 70 90 Electronic Safety and Security Supplementary Components	169
D80	21-04 80 Integrated Automation.....	169
D8010	21-04 80 10 Integrated Automation Facility Controls	169
E	21-05 00 00 EQUIPMENT & FURNISHINGS	170
E10	21-05 10 Equipment.....	170
E1010	21-05 10 10 Vehicle and Pedestrian Equipment	170
E1030	21-05 10 30 Commercial Equipment.....	171
E1040	21-05 10 40 Institutional Equipment.....	173

E1060	21-05 10 60 Residential Equipment	173
E1070	21-05 10 70 Entertainment and Recreational Equipment.....	174
E1090	21-05 10 90 Other Equipment Associated Masterformat Sections: 11 90 00	174
E20	21-05 20 Furnishings	175
E2010	21-05 20 10 Fixed Furnishings.....	175
E2050	21-05 20 50 Movable Furnishings	176
F	21-06 00 00 SPECIAL CONSTRUCTION & DEMOLITION	178
F10	21-06 10 Special Construction.....	178
F1010	21-06 10 10 Integrated Construction.....	178
F1020	21-06 10 20 Special Structures Associated Masterformat Sections: 13 30 00 / 01 88 13	178
F1030	21-06 10 30 Special Function Construction Associated Masterformat Sections:	186
F1050	21-06 10 50 Special Facility Components Associated Masterformat Sections:.....	186
F1060	21-06 10 60 Athletic and Recreational Special Construction.....	186
F1080	21-06 10 80 Special Instrumentation.....	186
F20	21-06 20 Facility Remediation Associated Masterformat Sections:	186
F2010	21-06 20 10 Hazardous Materials Remediation	186
F30	21-06 30 Demolition.....	186
F3010	21-06 30 10 Structure Demolition.....	186
F3030	21-06 30 30 Selective Demolition.....	186
F3050	21-06 30 50 Structure Moving	186
G	21-07 00 00 BUILDING SITEWORK	187
G10	21-07 10 Site Preparation	187
G1010	21-07 10 10 Site Clearing.....	187
G1020	21-07 10 20 Site Elements Demolition	187
G1030	21-07 10 30 Site Element Relocations	187
G1050	21-07 10 50 Site Remediation.....	187
G1070	21-07 10 70 Site Earthwork.....	187
G20	21-07 20 Site Improvements	188
G2010	21-07 20 10 Roadways	188
G2020	21-07 20 20 Parking Lots	188
G2030	21-07 20 30 Pedestrian Plazas and Walkways	189
G2040	21-07 20 40 Airfields	189
G2050	21-07 20 50 Athletic, Recreational, and Playfield Areas	189
G2060	21-07 20 60 Site Development.....	189
G2080	21-07 20 80 Landscaping.....	189
G30	21-07 30 Liquid and Gas Site Utilities	190
G3010	21-07 30 10 Water Utilities	190
G3020	21-07 30 20 Sanitary Sewerage Utilities	190
G3030	21-07 30 30 Storm Drainage Utilities	191
G3050	21-07 30 50 Site Energy Distribution.....	191
G3060	21-07 30 60 Site Fuel Distribution	191
G3090	21-07 30 90 Liquid and Gas Site Utilities Supplementary Components	191

G40	21-07 40 Electrical Site Improvements	191
G4010	21-07 40 10 Site Electric Distribution Systems.....	192
G4050	21-07 40 50 Site Lighting	193
G50	21-07 50 Site Communications	194
G5010	– Site Communications Systems	194
G90	21-07 90 Miscellaneous Site Construction	194
G9010	21-07 90 10 Tunnels	194
Highway Bridges Precast Structural I Girder (Concrete)		195
Highway Bridge Girder Steel		197
Railroad Bridges Precast Structural I Girder (Concrete).....		199
Railroad Bridge Girder Steel.....		201
Graphics Index		203
Appendix		i
Origins: Basis for all LOD		ii

INTRODUCTION

1 Overview

1.1 Description

The *Level of Development (LOD) Specification* is a reference that enables practitioners in the AEC Industry to specify and articulate with a high degree of clarity the content and reliability of Building Information Models (BIMs) at various stages in the design and construction process.

The Specification is a detailed interpretation of the LOD schema developed by the American Institute of Architects (AIA) for its *E202-2009 BIM and Digital Data Exhibit* and updated for its *G202-2013 Project BIM Protocol Form*¹, defining and illustrating² characteristics of model elements of different building systems at different Levels of Development, organized according to CSI Unifomat 2010³. Its intent is to help explain the LOD framework and standardize its use so that it becomes more useful as a communication tool.

The LOD Specification adheres to the intent of the LOD schema as developed by the AIA, and as such it is important to emphasize several points here.

1.1.1 LODs and Design Phase

The LODs are not defined by design phases. Rather, design phase completion, as well as any other milestone or deliverable, can be defined through the LOD language. There are several important reasons for this approach:

- 1) There is currently no detailed standard for the design phases. Many architects have created in-house standards, but these differ from one firm to the next, and even within a single firm the requirements are sometimes adjusted to the needs of a particular project.
- 2) Building systems progress from concept to precise definition at different rates, so at any given time different elements will be at different points along this progression. At completion of the Schematic Design phase, for example, the model will include many elements at LOD 200, but will also include many at LOD 100, as well as some at LOD 300, and possibly even LOD 400.

1.1.2 LODs and Model Definition

There is no such thing as an “LOD ### model.” As previously stated, project models at any stage of delivery will invariably contain elements and assemblies at various levels of development. As an example, it is not logical to require an “LOD 200 model” at the completion of the schematic design phase. Instead, the “100% SD Model” will contain modeled elements at various levels of development.

¹ AIA Contract Document *G202-2013, Building Information Modeling Protocol Form* is part of a series of digital practice documents the AIA published in June 2013. This series consists of *AIA E203™–2013, Building Information Modeling and Digital Data Exhibit*, *AIA G201™–2013, Project Digital Data Protocol Form*, and *AIA G202™–2013, Project Building Information Modeling Protocol Form*. For general information on the documents and downloadable samples see www.aia.org/digitaldocs. For executable versions of the documents see <http://www.aia.org/contractdocs>.

² All images are intended to illustrate building conditions in compliance with common building codes. However, the images do not take into account site specific conditions, regional building codes and other important information that may require a material change for specific projects. These illustrations do not make representation for fitness for a particular project nor for code or design compliance.

³ UniFormat™ Numbers and Titles used in this publication are from UniFormat™, published by CSI and Construction Specifications Canada (CSC), and are used with permission from CSI. For a more in-depth explanation of UniFormat™ and its use in the construction industry visit <http://www.csinet.org> or contact CSI, 110 South Union Street, Suite 100, Alexandria, VA 22314. (800) 689-2900.

1.2 Intent

1.2.1 Not a set of Requirements

The Specification is not a set of requirements as to what is modeled when or by whom. Rather it is a language by which users can define these requirements for their own firms or projects. This clear articulation allows model authors to define what their models can be relied on for, and allows downstream users to clearly understand the usability and the limitations of models they are receiving.

To accomplish the Specification's intent, its primary objectives are:

- 1) To help teams, including owners, to specify BIM deliverables and to get a clear picture of what will be included in a BIM deliverable
- 2) To help design managers explain to their teams the information and detail that needs to be provided at various points in the design process, and to track progress of their models
- 3) To allow downstream users to rely on specific information in models they receive from others.
- 4) To provide a standard that can be referenced by contracts and BIM execution plans.

1.2.2 Complements a BIM Execution Plan (BIMXP)

This Specification does not replace a project BIMXP, but rather is intended to be used in conjunction with such a plan, providing a means of defining models for specific information exchanges, milestones in a design work plan, and deliverables for specific functions.

1.3 Background

1.3.1 AIA Effort

In 2008, the AIA published its first set of Level of Development definitions in AIA Document *E202™-2008 Building Information Modeling Protocol*. Due to the rapidly evolving nature of the use of BIM, the AIA evaluated the *E202-2008*, including the LOD definitions. The result is the updated and reconfigured Digital Practice documents, *AIA E203™-2013, Building Information Modeling and Digital Data Exhibit*, *AIA G201™-2013, Project Digital Data Protocol Form*, and *AIA G202™-2013, Project Building Information Modeling Protocol Form*, which are accompanied by a detailed guide document entitled *Guide and Instructions to the AIA Digital Practice Documents*. The AIA's updated Digital Practice documents include revised LOD definitions.

1.3.2 BIMForum Effort

In 2011 the BIMForum initiated the development of this LOD Specification and formed a working group comprising contributors from both the design and construction sides of the major disciplines. To help further the standardization and consistent use of the LOD schema, and to increase its usefulness as a foundation for collaboration, the AIA licensed the BIMForum to utilize its latest LOD definitions in this Specification. The BIMForum working group first interpreted the AIA's basic LOD definitions for each building system, and then compiled examples to illustrate the interpretations. Because BIM is being put to an ever increasing number of uses, the group decided that it was beyond the initial scope to address all of them. Instead, the definitions were developed to address model element geometry, with three of the most common uses in mind – quantity take-off, 3D coordination and 3D control and planning. The group felt that in taking this approach the interpretations would be complete enough to support other uses.

1.3.3 LOD Definitions

The LOD definitions that are used in this Specification are identical to those published in the AIA's updated Digital Practice Documents, with two exceptions.

- 1) First, the working group identified the need for an LOD that would define model elements sufficiently developed to enable detailed coordination between disciplines – e.g. clash detection/avoidance, layout, etc. The requirements for this level are higher than those for 300, but not as high as those for 400, thus it was designated LOD 350. The AIA documents do not include LOD 350, but the associated *Guide and Instructions* references it.
- 2) Second, while LOD 500 is included in the AIA's LOD definitions, the working group did not feel it was necessary to further define and illustrate LOD 500 in this Specification because it relates to field verification. Accordingly, the expanded descriptions and graphic illustrations in this Specification are limited to LOD 100-400.

2 Levels of Development

2.1 BIM as a Communication Tool

The LOD schema addresses several issues that arise when a BIM is used as a communication or collaboration tool, i.e., when someone other than the author extracts information from it:

- 1) During the design process, building systems and components progress from a vague conceptual idea to a precise description. In the past there has been no simple way to designate where a model element is along this path. The author knows, but others often don't.
- 2) It's easy to misinterpret the precision at which an element is modeled. Hand drawings range from pen strokes on a napkin to hard lines with dimensions called out, and the precision of the drawing can be inferred from its appearance. In a model though, a generic component placed approximately can look exactly the same as a specific component located precisely, so we need something besides appearance to tell the difference.
- 3) It is possible to infer or extract information from a BIM that the author doesn't intend – unconfirmed dimensions can be measured with precision, assembly information often exists before it's been finalized, etc. In the past, this issue has been sidestepped with all-encompassing disclaimers that basically say, "Since some of the information in the model is unreliable, you may not rely on any of it." The LOD framework allows model authors to clearly state the reliability of given model elements, so the concept becomes "Since some of the information in the model is unreliable, you may only rely on it for what I specifically say you can."
- 4) In a collaborative environment, where people other than the model author are depending on information from the model in order to move their own work forward, the design work plan takes on high importance – it is necessary for the model users to know when information will be available in order to plan their work. The LOD framework facilitates this.

The LOD Framework addresses these issues by providing an industry-developed standard to describe the state of development of various systems, assemblies, and components within a BIM. This standard enables consistency in communication and execution by facilitating the detailed definition of BIM milestones and deliverables.

2.2 Level of Development vs. Level of Detail

LOD is sometimes interpreted as Level of *Detail* rather than Level of *Development*. This Specification uses the concept of Level of *Development*. There are important differences.

Level of *Detail* is essentially how *much* detail is included in the model element. Level of *Development* is the *degree to which the element's geometry and attached information has been thought through* – the degree to which project team members may rely on the information when using the model.

In essence, Level of Detail can be thought of as input to the element, while Level of Development is reliable output.

2.3 Fundamental LOD Definitions ⁴

2.3.1 LOD 100

The Model Element may be graphically represented in the Model with a symbol or other generic representation, but does not satisfy the requirements for LOD 200. Information related to the Model Element (i.e. cost per square foot, tonnage of HVAC, etc.) can be derived from other Model Elements.

BIMForum Interpretation: LOD 100 elements are not geometric representations. Examples are information attached to other model elements or symbols showing the existence of a component but not its shape, size, or precise location. Any information derived from LOD 100 elements must be considered approximate.

2.3.2 LOD 200

The Model Element is graphically represented within the Model as a generic system, object, or assembly with approximate quantities, size, shape, location, and orientation. Non-graphic information may also be attached to the Model Element.

⁴ The definitions for LOD 100, 200, 300, 400, and 500 included in this Specification represent the updated language that appears in the AIA's most recent BIM protocol document, *G202-2013, Building Information Modeling Protocol Form*. The LOD 100, 200, 300, 400 and 500 definitions are produced by the AIA and have been used by permission. Copyright © 2013. The American Institute of Architects. All rights reserved. LOD 350 was developed by the BIMForum working group. Copyright © 2013. The BIMForum and the American Institute of Architects. All rights reserved.

BIMForum interpretation: At this LOD elements are generic placeholders. They may be recognizable as the components they represent, or they may be volumes for space reservation. Any information derived from LOD 200 elements must be considered approximate.

2.3.3 LOD 300

The Model Element is graphically represented within the Model as a specific system, object or assembly in terms of quantity, size, shape, location, and orientation. Non-graphic information may also be attached to the Model Element.

BIMForum interpretation: The quantity, size, shape, location, and orientation of the element as designed can be measured directly from the model without referring to non-modeled information such as notes or dimension call-outs.

2.3.4 LOD 350

The Model Element is graphically represented within the Model as a specific system, object, or assembly in terms of quantity, size, shape, location, orientation, and interfaces with other building systems. Non-graphic information may also be attached to the Model Element.

BIMForum interpretation. Parts necessary for coordination of the element with nearby or attached elements are modeled. These parts will include such items as supports and connections. The quantity, size, shape, location, and orientation of the element as designed can be measured directly from the model without referring to non-modeled information such as notes or dimension call-outs.

2.3.5 LOD 400

The Model Element is graphically represented within the Model as a specific system, object or assembly in terms of size, shape, location, quantity, and orientation with detailing, fabrication, assembly, and installation information. Non-graphic information may also be attached to the Model Element.

BIMForum interpretation. An LOD 400 element is modeled at sufficient detail and accuracy for fabrication of the represented component. The quantity, size, shape, location, and orientation of the element as designed can be measured directly from the model without referring to non-modeled information such as notes or dimension call-outs.

2.3.6 LOD 500

The Model Element is a field verified representation in terms of size, shape, location, quantity, and orientation. Non-graphic information may also be attached to the Model Elements.

BIMForum interpretation. Since LOD 500 relates to field verification and is not an indication of progression to a higher level of model element geometry or non-graphic information, this Specification does not define or illustrate it.

2.4 Example – Light Fixture:

- 100 cost/sf attached to floor slabs
- 200 light fixture, generic/approximate size/shape/location
- 300 Design specified 2x4 troffer, specific size/shape/location
- 350 Actual model, Lightolier DPA2G12LS232, specific size/shape/location
- 400 As 350, plus special mounting details, as in a decorative soffit

3 Using the Specification

3.1 Glossary

The expanded definitions in this Specification use the following interpretations of these terms:

3.1.1 Specific:

The quantity, size, shape, location, and orientation of the element as designed can be measured directly from the model without referring to non-modeled information such as notes or dimension call-outs.

3.1.2 Actual:

The model element includes all the qualities of a specific element and is representative of the manufacturer's model to be installed or the construction intent of an assembly.

3.2 Details

3.2.1 Order of Precedence

The body of this Specification expands on the Fundamental Definitions as they apply to specific building systems and sub-systems. In the event of any conflict, more specific expansions take precedence over less specific expansions and Fundamental Definitions, e.g. the expanded definitions for C1010 take precedence over those for C10, which in turn take precedence over the Fundamental Definitions.

3.2.2 LOD Definitions as Minimum Requirements

The LODs provide five snapshots of the progression of an element from conceptual to specified – there are many steps in this progression between the defined LODs. The LOD definitions, then, should be considered minimum requirements – i.e. an element has progressed to a given LOD only when all the requirements stated in the definition have been met.

3.2.3 LOD Definitions are Cumulative

For a given element each LOD definition includes the requirements of all previous LODs. Thus for an element to qualify for LOD 300 it must meet all the requirements for 200 and 100 as well as those stated in the LOD 300 definition.

3.2.4 Model Element Author

This document does not prescribe who the author of a particular component at a given LOD should be – the sequence of responsibility for modeling various systems will vary from one project to another. To accommodate this variation this document defers to the concept of Model Element Author (MEA) as defined in the *AIA E203-2013*: “The Model Element Author is the entity (or individual) responsible for managing and coordinating the development of a specific Model Element to the LOD required for an identified Project milestone, regardless of who is responsible for providing the content in the Model Element.”⁵

3.2.5 2D Supplementary Drawings

In current practice models are often supplemented with 2D information such as detail drawings. This Specification does not address this supplementation, but rather deals only with what is actually modeled in 3D and non-graphic information associated with the modeled elements.

3.3 Project-Specific Information

As mentioned in the Overview above, this Specification is intended to be used in conjunction with a project BIMXP. Many information needs will vary from project to project, even for identical elements. This kind of information is therefore not included in the LOD definitions specified here, but rather is left to be addressed in individual BIMXPs. The following are some notable examples.

3.3.1 Size Thresholds

In most projects a determination is made to model certain elements only if they are over a specified size – e.g. conduit less than 1/2” (10 mm) diameter is not modeled. These size thresholds do not consistently correspond to certain LODs, and they vary from project to project. Thus they are not specified in the LOD definitions but rather in the project’s BIMXP, for example through the “Notes” cells in the Model Element Table of the *AIA G202-2013*.

3.3.2 Clearances

Clearances such as door swings, maintenance access zones, and accessibility requirements can be critical design issues and in many cases are geometrically modeled to reserve the space. The implementation of this type of spatial coordination can be accomplished in various ways; therefore, it is neither practical nor useful for this Specification to dictate particular requirements, for example, *all door swings to be modeled as quarter-cylinder solids*. Implementation of required clearances is to be established within individual BIMXPs.

3.4 Using the Specification with a BIMXP

Most BIMXPs include a section that details milestones as well as information exchanges – models to be produced to exchange specific information at specific points in a specific BIM use. In most cases, though, current practice is to accompany these models with the common “for reference only” disclaimer, diluting the effectiveness of the exchange. Referencing this Specification in the BIMXP and using it to concisely define the milestone and information exchange models brings many efficiencies to the process – among them:

⁵ AIA Document *E203-2013 Building Information Modeling and Digital Data Exhibit*, Article 1.4.6. Copyright © American Institute of Architects 2013. All rights reserved. Definition quoted here by permission.

3.4.1 Reliance

As noted above (see “BIM as a Communication Tool”), a major problem with allowing others to rely on a BIM is that it can contain information the author doesn’t intend. By defining a model through the LOD Specification the author can limit reliance to only what he/she specifically states.

3.4.2 Multiple uses

Much model information is common across several information exchanges. This Specification facilitates the definition of models that will support multiple exchanges.

3.4.3 Efficient sequencing

The development of models as the design and construction process progresses follows logical sequences – much information depending on the prior development of other information. The definition of milestones, information exchanges, and other deliverables through this Specification facilitates the orderly sequencing of models to align with efficient development of information.

3.4.4 Avoidance of over-modeling

The LOD Specification facilitates the application of a pull-planning process to the modeling effort, limiting the development of model elements and information to that which the team identifies as useful.

Note that the definition and sequencing of models usually cannot be set in stone when the BIMXP is first developed. In most cases the modeling plan must evolve as the project progresses.

3.5 Implementation of the Specification

Currently, two methods of implementation have been developed.

3.5.1 Rely on the Model Element Table

Project team refers to the model element table included in an AIA G202 document or a BIM execution plan for the LODs of model elements. In this method all elements referred to in a given model element table line item are assumed to be at the LOD stated there. E.g. if the table lists interior doors as LOD 200 for a given model, all interior doors within the model are assumed to be at LOD 200.

3.5.2 Include LOD Designations as Attributes of Individual Model Elements

All elements within the model are provided with two attributes – Current LOD (the actual LOD of the element) and Target LOD (the LOD specified for that element in the model element table). Elements default to a Current LOD of 100 or 200 as appropriate, and this attribute is elevated as the element is more fully developed. This method offers more flexibility and reliability, allowing differentiation between individual elements within a single model element table line item. Several software offerings provide the functionality of highlighting elements of various LODs or elements whose Current LOD is less than the Target LOD.

4 Organization of the Specification

4.1 Geometric and Attribute Information

To facilitate use of this Specification Attachment 1, Model Development Specification (MDS) has been provided. This attachment is a set of spreadsheets that can be used to collect and correlate LOD Information for a specific project.

A model element can contain two types of information: a) the element’s geometry and b) associated numeric and/or textual attributes. To address these types of information this Specification contains two parts:

4.1.1 Part I: Element Geometry

Part I consists of narrative descriptions and illustrations of specific model elements at each LOD. Part I forms the bulk of this document.

4.1.2 Part II: Associated Attribute Information

Part II is contained in Attachment 1, a workbook that begins with the Model Element Table which mirrors the layout of the Model Element Table in the AIA *G202-2013 Building Information Modeling Protocol Form*, and can be referenced by that document. The Model Element Table references Attribute Tables that contain attribute information for various building systems.

4.1.3 Model Element Table

UnifFormat Level	1	2	3	4	Use on this project	System	Relevant Attribute Tables	SD			DD			CD			Estimating			LEED Cert.			LEED Cert							
								Date	LOD	MEA	Notes	Date	LOD	MEA	Notes	Date	LOD	MEA	Notes	Est. 1 Date	LOD	MEA	Notes	Check Date	LOD	MEA	Notes	Submittal Date	LOD	MEA
SUBSTRUCTURE																														
A	10						Foundations	A, B Concrete; A, B Wood; A, B Masonry; A, B Precast Concrete																						
A	10	10					Standard Foundations	A, B Concrete; A, B Wood; A, B Masonry; A, B Precast Concrete																						
A	10	10	.10				Wall Foundations	A, B Concrete; A, B Wood; A, B Masonry; A, B Precast Concrete																						
A	10	10	.30				Column Foundations	A, B Concrete; A, B Wood; A, B Masonry; A, B Precast Concrete																						
A	10	20					Special Foundations	A, B Concrete; A, B Wood; A, B Masonry; A, B Precast Concrete																						
A	10	20	.80				Grade Beams	A, B Concrete; A, B Wood; A, B Masonry; A, B Precast Concrete																						
A	20						Subgrade Enclosures	A, B Concrete; A, B Wood; A, B Masonry; A, B Precast Concrete																						
A	20	10					Walls for Subgrade Enclosures	A, B Concrete; A, B Wood; A, B Masonry; A, B Precast Concrete																						
A	40						Slabs-on-Grade	A, B Str. Concrete																						
A	40	10					Standard Slabs-on-Grade	A, B Concrete																						
A	40	20					Structural Slabs-on-Grade	A, B Concrete																						
SHELL																														
B	10						Superstructure																							
B	10	10					Floor Construction	A, B Cold Formed Metal Framing; A, B Masonry; A, B Metal Deck; A, B Precast Concrete; A, B Steel Joist; A, B Structural Steel; A, B Concrete; A, B Wood																						
B	10	10	.10				Floor Structural Frame																							
B	10	10	.10				Concrete	A, B Concrete																						
B	10	10	.10				Masonry	A, B Masonry																						

Figure 1

4.1.4 Building Systems

The rows of the Model Element Table (Figure 1) are building elements listed in accordance with CSI Unifformat 2010. The table also lists Relevant Attribute Tables for each system, referring to the tabs containing attribute information for the associated system(s). If desired users can add Attribute Tables for specific line items.

4.1.5 Milestones/Deliverables

The table includes columns for defining the LODs for various milestones within a project. Each milestone column has three sub-columns: Level of Development (LOD), Model Element Author (MEA), and Notes. The table in Attachment 1 shows standard milestones for the completion of the traditional design phases as well as examples of Project-Specific Milestones for interim reviews, specific deliverables, BIM-Use information exchanges, etc. Users are encouraged to modify and add to these milestones as necessary. Once the milestones for a project have been determined, they can be re-ordered into a logical sequence as in Figure 2.

UnifFormat Level	1	2	3	4	Use on this project	System	Relevant Attribute Tables	SD			DD			CD			Estimating			LEED Cert.			LEED Cert							
								Date	LOD	MEA	Notes	Date	LOD	MEA	Notes	Date	LOD	MEA	Notes	Est. 1 Date	LOD	MEA	Notes	Check Date	LOD	MEA	Notes	Submittal Date	LOD	MEA
SUBSTRUCTURE																														
A	10						Foundations	A, B Concrete; A, B Wood; A, B Masonry; A, B Precast Concrete																						
A	10	10					Standard Foundations	A, B Concrete; A, B Wood; A, B Masonry; A, B Precast Concrete																						
A	10	10	.10				Wall Foundations	A, B Concrete; A, B Wood; A, B Masonry; A, B Precast Concrete																						
A	10	10	.30				Column Foundations	A, B Concrete; A, B Wood; A, B Masonry; A, B Precast Concrete																						
A	10	20					Special Foundations	A, B Concrete; A, B Wood; A, B Masonry; A, B Precast Concrete																						
A	10	20	.80				Grade Beams	A, B Concrete; A, B Wood; A, B Masonry; A, B Precast Concrete																						
A	20						Subgrade Enclosures	A, B Concrete; A, B Wood; A, B Masonry; A, B Precast Concrete																						
A	20	10					Walls for Subgrade Enclosures	A, B Concrete; A, B Wood; A, B Masonry; A, B Precast Concrete																						
A	40						Slabs-on-Grade	A, B Str. Concrete																						
A	40	10					Standard Slabs-on-Grade	A, B Concrete																						
A	40	20					Structural Slabs-on-Grade	A, B Concrete																						
SHELL																														
B	10						Superstructure																							
B	10	10					Floor Construction	A, B Cold Formed Metal Framing; A, B Masonry; A, B Metal Deck; A, B Precast Concrete; A, B Steel Joist; A, B Structural Steel; A, B Concrete; A, B Wood																						
B	10	10	.10				Floor Structural Frame																							
B	10	10	.10				Concrete	A, B Concrete																						
B	10	10	.10				Masonry	A, B Masonry																						

Figure 2

4.1.6 Attribute Tables

B – Ext. Glazed Openings		Part 1 - Attribute Description				Part 2 - LOD Profile					Part 3 - Project-Specific Milestones (Examples)			
Baseline						100	200	300	350	400	Estimating	Estimating	LEED Cert.	LEED Cert.
Additional		Date Type	Units	Option Examples	Commentary						Est. 1	Bid Pkg.	Check	Submittal
Construction	Text			options(United Combined glass and frame), Slid Bolt, Structural Glass			x	x	x	x				
Material	Text			options(Aluminum Framed, Bronze Framed, Stainless Steel Framed, Channel Glass)				x	x	x				
Thermal Resistance	Number	R-Value						x	x	x				
Condensation Resistance				options(see, no. glass)										
Windbourne Debris Resistance		psf												
Wind Load Capacity		psf												
Glazing Method				options(Conventional, Two Sided, Three Sided, Four Sided, Five Sided)										
Glass - Material				options(Glass, Plastic)										
Glass - Configuration				options(Monolithic, Insulating)										
Glass - Condition				options, multiple (Annealed, Heat Strengthened, Tempered, Laminated, Bent)										
Glass - Coatings				options, multiple (Purified (hard coat), Sputter (soft coat), Low E, Metallic, Ceramic Fin, Open Coat, Digital Printed)										
Glass - Use				options, multiple (Glazing into conventional application, Glazing into structurally glazed application, Mirror, Decorative, Fire Resistant, Hurricane Resistant, Cable Suspended, Switchable Glass, Electrochromically Controlled switchable Glass, Pressure Resistant, Radiation Resistant, Security, Ballistic)										

Figure 3

4.1.7 Attribute Table Anatomy

Attribute Tables consist of three parts.

- 1) Part 1, Attribute Description, lists Attributes relevant to the associated building system(s). Attributes are grouped into two categories as shown – Baseline and Additional.
 - The Baseline is the suggested list of attributes to be populated when no other requirements are known (BIM Uses, specific deliverables, etc.).
 - The Additional category may be thought of as a “shopping list” – a list of possible attributes the team may want to consider.
- 2) Part 2, LOD Profile, correlates Attribute requirements with LODs from the Model Element Table. Attributes with pre-populated LOD Profiles show a correlation between Attributes and LODs that represents current practices of proficient BIM users. An “X” can be entered in these cells to indicate simply that the attribute is required at a given LOD, or an Attribute Author can be entered to indicate not only that the attribute is required but also who is responsible for providing it.
- 3) Part 3, Milestones, is used to mark the attributes required for specific milestones and deliverables. The tables in Attachment 1 include example milestones, but users will customize the tables by copying the milestones they created for the Model Element Table.

4.1.8 MEPF Attribute Tables

The MEPF attribute tables use a somewhat different format than other sections, since components from multiple systems might be used to make up a specific element. Case in point, an air handler is primarily a D30 HVAC element, but can include plumbing, fire protection and electrical elements as well.

The MEP Systems tabs are grouped into two types:

- **System component elements:** D20 Plumbing, D30 HVAC, D40 Fire Protection and D50 Electrical.
- **System distribution elements** such as ducts, pipes, and cables: D Air Distribution, D Fluid Gas Distribution and D Electrical Distribution.

MEPF attribute tables are broken down into two main sections

- **Global:** Attributes that are common to all elements within the table
- **Item-Specific:** The suggested set of additional attributes that are specific to an individual type of element. In many tables the individual elements are organized into a hierarchy of classes and sub-classes. In these cases the attributes applicable to a specific element include those listed for the element itself plus those listed in any of the classes above it in the hierarchy. E.g. as Figure 4 shows, the attributes for an oil meter include all those shown in bold.

Note: System Component elements use both the Global and Item-Specific attributes sections, while System Distribution elements use only the Item-Specific attribute section.

Figure 4

4.1.9 Using the Attribute Tables

There are many ways to use the Attribute Tables – three are shown here.

- 1) Project teams adopt the Baseline attribute lists. The pre-populated correlation between Attributes and LODs represents current practices of proficient BIM users in the AEC industry.
- 2) Project teams create a custom correlation between LODs and Attribute population requirements. In this case the project team would edit the LOD Profile section to reflect the specific requirements of the project.
- 3) Project teams create new, project specific milestones and define Attribute population requirements in the Milestones sections. This approach will give project teams the greatest flexibility for defining Attribute population requirements.

Note that the element attribute author can be entered in the LOD profile instead of an “x” to indicate who is responsible for providing the information.

5 Updates of This Document

While this document is intended as a reference that can be cited in agreements such as contracts and BIM execution plans, it is recognized that the use of BIM in design and construction is evolving. To accommodate this evolution this document will be updated periodically in clearly identifiable versions. A project can adopt a specific version and then has the option to remain with that version or update if a new version is published. Initially the target update frequency is annually, but that may change in the future. In addition, interim updates may be issued if needed.

5.1 Revision History

08/25/16	Level of Development Specification 2016 DRAFT FOR PUBLIC COMMENT	New changes are noted with a bold bar. Definitions have not been changed except for minor grammatical corrections and formatting.
10/30/15	Level of Development Specification 2015	New changes are noted with a bold bar. Definitions have not been changed except for minor grammatical corrections and formatting. New content released as an Appendix to Part A for engineered metal building structures, precast concrete, highway bridge content and rail road bridge content.
4/30/15	Level of Development Specification 2015 DRAFT FOR PUBLIC COMMENT	New changes are noted with a bold bar. Definitions have not been changed except for minor grammatical corrections and formatting. Part B, Model Element Table, and Attribute Tables were added.
12/30/14	Level of Development Specification 2014	New changes are noted with a bold bar. Definitions have not been changed except for minor grammatical corrections and formatting. Images and image notes have been added in <i>blue italics font</i> .
8/22/13	Level of Development Specification 2013	
4/24/13	Initial draft for public review	

5.2 Revision Process

5.2.1 Public Comment

Each new version is first released as a draft for public comment. Feedback is evaluated and resolved prior to the publishing of the official version.

5.2.2 Appendix

An increasing number of professional organizations are adopting this Specification and providing additional content relating to their domains. To accommodate information that becomes available after the public-comment release but prior to the final release, content is developed in collaboration with industry organizations and leading expert practitioners, and then vetted by the LOD working group. This content is released as an Appendix to Part A and as additional identified Attribute Table tabs in Part B. The new content is then integrated into the next public comment draft.

Reference Part II Attribute Tables for non-graphical information

PART I – ELEMENT GEOMETRY

A 21-01 SUBSTRUCTURE

Associated Masterformat Sections: 01 82 00

A10 21-01 10 Foundations

Associated Masterformat Sections: 01 82 13

100	Assumptions for foundations are included in other modeled elements such as an architectural floor element or volumetric mass that contains layer for assumed structural framing depth. Or, schematic elements that are not distinguishable by type or material. Assembly depth/thickness and locations still flexible.	
200	Element modeling to include: <ul style="list-style-type: none"> • Approximate size and shape of foundation element • Structural building grids for local project coordinate system are defined in model and coordinated with global civil coordinate system (State Plane Coordinate System, etc.) 	

A1010 21-01 10 10 Standard Foundations

Includes: Formwork, concrete, masonry and reinforcement. Includes Standard Foundation Supplementary Components as appropriate. May Include: Related Activities: Excavation, dewatering, excavation support systems, backfill and compaction, and soil treatment.

Associated Masterformat Sections:

100	See A10	
200	See A10	
300	Elements are modeled to the design-specified size and shape of the foundation. Element modeling to include: <ul style="list-style-type: none"> • Overall size and geometry of the foundation element • Sloping surfaces or floor depressions • External dimensions of the members • Main openings such as elevators and other shafts 	

Reference Part II Attribute Tables for non-graphical information

A1010.10 21-01 10 10 10 Wall Foundations (Shallow Foundations)

Associated Masterformat Sections: 03 30 00 / 03 40 00 / 04 20 00 / 06 14 00

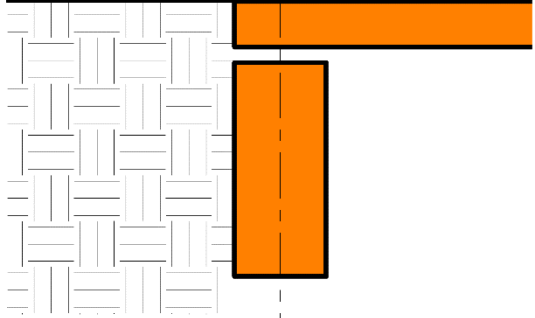
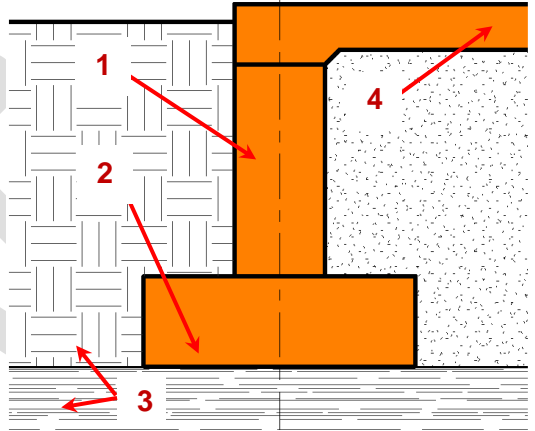
100	See A10	
200	<p>See A10</p> <p><i>Image Notes:</i></p> <ol style="list-style-type: none"> 1) <i>Generic wall foundation is modeled.</i> 2) <i>Site is generically modeled from geotechnical information in geotechnical report.</i> 	 <p>5 A1010.10-LOD-200 Wall Foundation</p>
300	<p>Element modeling to include:</p> <ol style="list-style-type: none"> 1) Overall size and geometry of the foundation element 2) Sloping surfaces. 3) External dimensions of the members 4) Geotechnical bearing strata elevation is modeled from geotechnical report. <p><i>Image Notes:</i></p> <ol style="list-style-type: none"> 1) <i>Wall foundation sizes are accurately modeled with footings where applicable.</i> 2) <i>Bearing elevation is modeled from the geotechnical report.</i> 3) <i>Geotechnical regions are shown for context and not required to be modeled as part of this element at this LOD.</i> 4) <i>See slab on grade for related conditions at this LOD.</i> 	 <p>6 A1010.10-LOD-300 Wall Foundation</p>

Reference Part II Attribute Tables for non-graphical information

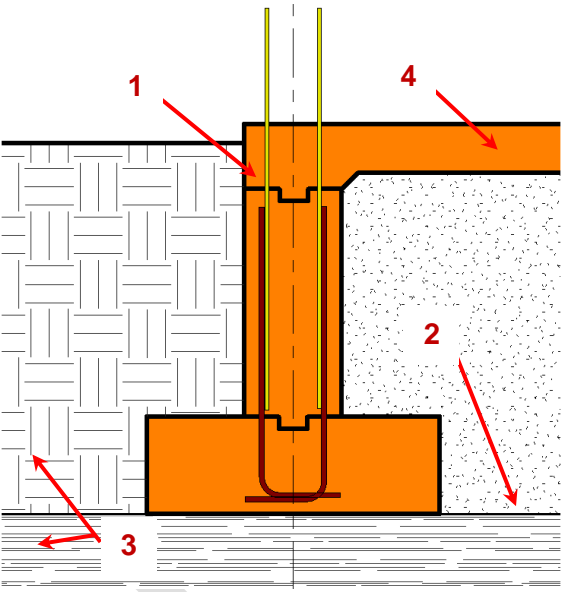
<p>350</p>	<p>Element modeling to include:</p> <ul style="list-style-type: none"> • Location of sleeve penetrations • Pour joints • Moisture retarder • Dowels • All exposed embeds or reinforcement such as lintels • Expansion joints • Geotechnical Bearing Strata is modeled from geotechnical report estimates. • Area of bearing influence <p><i>Image Notes:</i></p> <ol style="list-style-type: none"> 1) <i>Grade beam sizes are modeled with interfaces to other systems such as but not limited to slab turn downs, key-ways between concrete pours, construction joints and reinforcing dowels into adjacent pours.</i> 2) <i>Bearing elevation is modeled from the geotechnical report with the addition on interface elements such as void boxes where applicable.</i> 3) <i>Geotechnical regions are shown for context and not required to be modeled as part of this element at this LOD.</i> 4) <i>See slab on grade for related conditions at this LOD.</i> 	 <p>7 A1010.10-LOD-350 Wall Foundations (Shallow Foundations)</p>
<p>400</p>	<p>Element modeling to include:</p> <ul style="list-style-type: none"> • Rebar including hooks and lap splices • Dowels • Chamfer • Coursing for unit masonry defined • Waterproofing 	

Reference Part II Attribute Tables for non-graphical information

A1010.30

21-01 10 10 30

Column Foundations (Deep Foundations)

Associated Masterformat Sections: 03 30 00

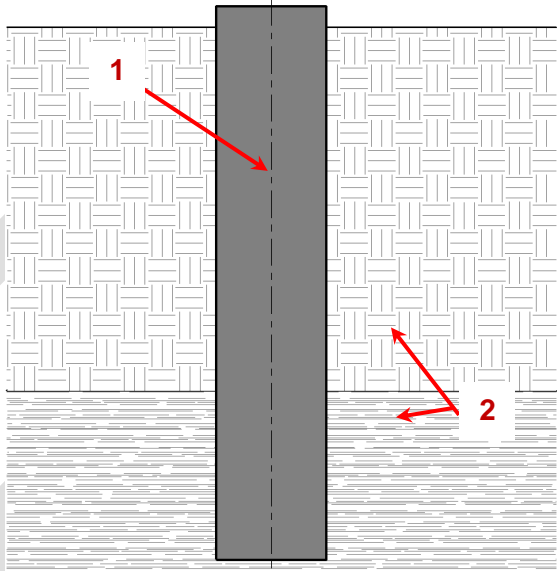
100	See A10	
200	See A10	
300	<p>Element modeling to include:</p> <ul style="list-style-type: none"> • Assumed bearing depth per geotechnical report with designed penetration geometry modeled. • <i>Top of Pier</i> • <i>Size of Pier</i> <p><i>Image Notes:</i></p> <ol style="list-style-type: none"> 1) <i>Pier sizes are accurately modeled with top of pier elevation, estimated depth to bearing and specified depth of penetration into bearing strata.</i> 2) <i>Geotechnical regions are shown for context and not required to be modeled as part of this element at this LOD.</i> 	 <p>8 A1010.30-LOD-300 Column Foundations (Deep Foundations)</p>

Reference Part II Attribute Tables for non-graphical information

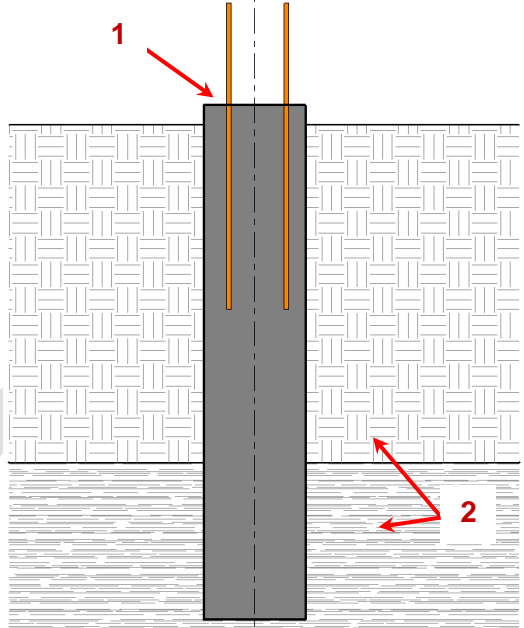
<p>350</p>	<p>Element modeling to include:</p> <ul style="list-style-type: none"> Actual Top of Pier (TOP) and expected Bottom of Pier (BOT) modeled per engineer's review of site conditions Foundation dowel locations and anchor rods if applicable. <p><i>Image Notes:</i></p> <ol style="list-style-type: none"> Pier sizes are accurately modeled with interfaces to other systems such as but not limited to slab turn downs, key-ways between concrete pours, construction joints and reinforcing dowels into adjacent pours. Geotechnical regions are shown for context and not required to be modeled as part of this element at this LOD. 	 <p>9 A1010.30-LOD-350 Column Foundations</p>
------------	---	---

Reference Part II Attribute Tables for non-graphical information

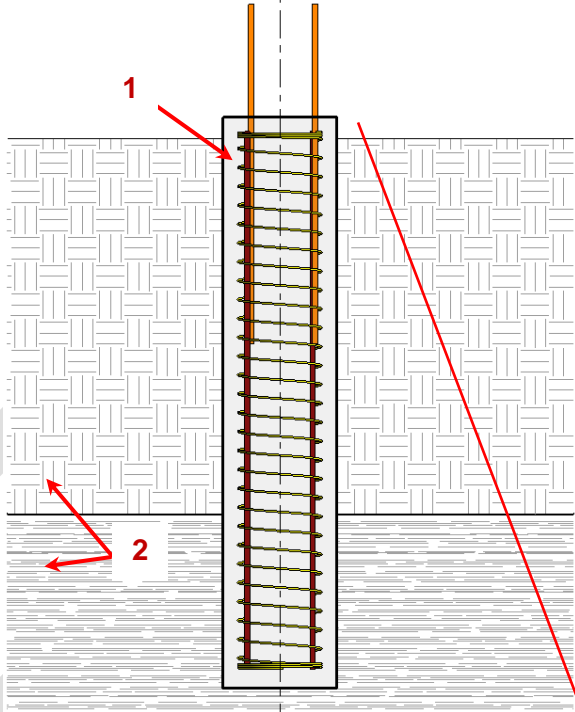
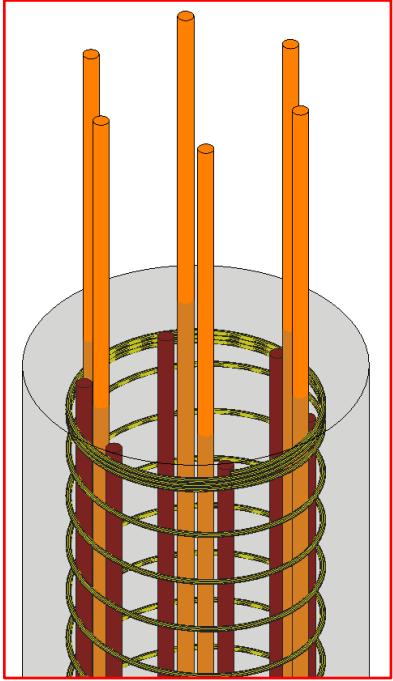
<p>400</p>	<p>Element modeling to include:</p> <ul style="list-style-type: none">• Depth to bearing stratum• Penetration into bearing stratum• Locations of lap splices• Rebar detailing including hooks and lap splices• Dowels• Pier sled or Pier wheel for side clear cover• Pier bolster for bottom clear cover <p><i>Image Notes:</i></p> <ol style="list-style-type: none">1) Pier modeling is developed to include all fabrication content that is part of the element.2) Geotechnical regions are shown for context and not required to be modeled as part of this element at this LOD.3) Pier sled, pier wheel, pier bolsters and other related items are not shown in image for clarity.	 <p>The diagram illustrates a column foundation with rebar detailing. A central vertical column is shown with a rebar cage. The rebar cage consists of vertical longitudinal bars and horizontal transverse bars. The column is shown in a cross-section, with a dashed line indicating the centerline. A red arrow labeled '1' points to the top of the rebar cage. A red arrow labeled '2' points to the bottom of the rebar cage. The diagram also shows a geotechnical context with a bearing stratum and a bearing stratum below it. A red line indicates a zoomed-in view of the rebar cage.</p>  <p>The zoomed-in view shows the rebar cage in detail, with vertical longitudinal bars and horizontal transverse bars. The bars are shown in a 3D perspective view, with the vertical bars in orange and the horizontal bars in green. The rebar cage is shown in a cylindrical container.</p> <p>10 A1010.30-LOD-400 Column Foundations</p>
------------	---	--

Unifomat **Omniclass**

Reference Part II Attribute Tables for non-graphical information

A1010.90 21-01-10 10 90 Standard Foundation Supplementary Components TBD

A1020 21-01 10 20 Special Foundations

Includes: Drilling, casing, bell bottom, excavation, dewatering, removal of excavated, materials, reinforcing, and concrete. Drilled Piers, Driven Piles, Mat Foundation, elevator pits.

Associated Masterformat Sections: 31 60 00

100	See A10	
200	See A10	
300	See A1010 <ul style="list-style-type: none"> • Elevator pit slabs are sloped correctly • Sump pits are shown at correct locations and geometries 	
350	Element modeling to include: <ul style="list-style-type: none"> • Location and size of sleeve penetrations and MEP openings • Pour joints • Dowels • All elements needed for cross-trade collaboration are to be modeled • Actual location and shape of structural element • Exposed embeds or reinforcement such as lintels • Penetrations detailed and modeled • Expansion joints 	
400	Element modeling to include: <ul style="list-style-type: none"> • Rebar detailing including hooks and lap splices • Dowels • Chamfer • Moisture retarder • Coursing for unit masonry defined • Waterproofing 	

Reference Part II Attribute Tables for non-graphical information

A10d0.10	21-01 10 20 20	Driven Piles	TBD
A1020.20	21-01 10 20 20	Caissons	TBD
A1020.30	21-01 10 20 30	Special Foundation Walls	TBD
A1020.40	21-01 10 20 40	Foundation Anchors	TBD
A1020.50	21-01 10 20 50	Underpinning	TBD
A1020.60	21-01 10 20 60	Raft Foundations	TBD
A1020.70	21-01 10 20 70	Pile Caps	TBD

A1020.80 21-01 10 20 80 Grade Beams

Includes: Formwork, reinforcement, and concrete.

Associated Masterformat Sections: 03 30 00

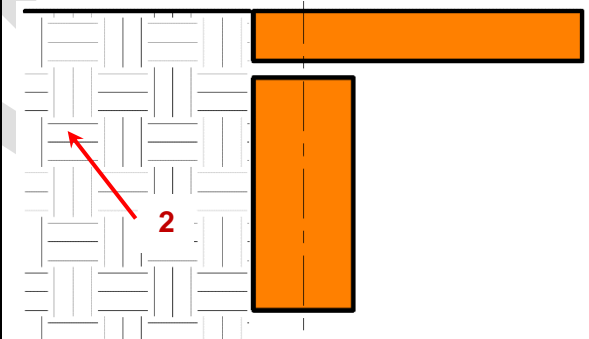
100	See A10	
200	See A10 <i>Image Notes:</i> 1) <i>Generic beam geometry is shown.</i> 2) <i>Geotechnical regions are shown for context and not required to be modeled as part of this element at this LOD.</i>	 <p style="text-align: center;">11 A1020.80-LOD-200 Grade Beams</p>

Reference Part II Attribute Tables for non-graphical information

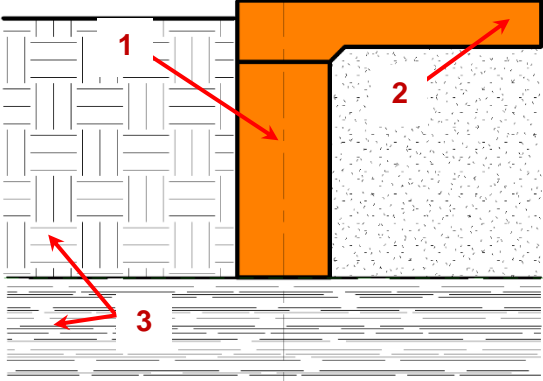
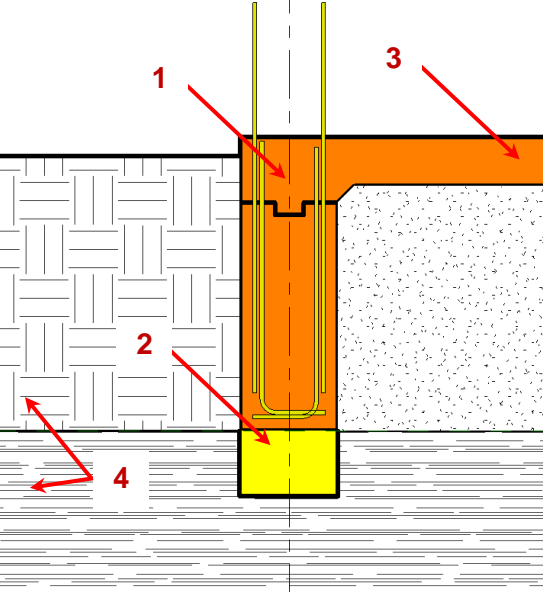
<p>300</p>	<p>See A1010</p> <p><i>Image Notes:</i></p> <ol style="list-style-type: none"> 1) See slab on grade for related conditions at this LOD. 3) Geotechnical regions are shown for context and not required to be modeled as part of this element at this LOD. 	 <p>12 A1020.80-LOD-300 Grade Beams</p>
<p>350</p>	<p>Element modeling to include:</p> <ol style="list-style-type: none"> 1) Water stops 2) Pour joints and sequences required to identify reinforcing lap splice, scheduling, etc. <p><i>Image Notes:</i></p> <ol style="list-style-type: none"> 1) Grade beam sizes are modeled with interfaces to other systems such as but not limited to slab turn downs, key-ways between concrete pours, construction joints and reinforcing dowels into adjacent pours. 2) Interface elements such as void boxes or critical bearing zones are modeled where applicable. 3) See slab on grade for related conditions at this LOD. 4) Geotechnical regions are shown for context and not required to be modeled as part of this element at this LOD. 	 <p>13 A1020.80-LOD-350 Grade Beams</p>
<p>400</p>	<p>Element modeling to include:</p> <ul style="list-style-type: none"> • Detailed post-tensioned components • Rebar including hooks and lap splices • Dowels • Chamfer • Waterproofing 	

Reference Part II Attribute Tables for non-graphical information**A20 21-01 20 Subgrade Enclosures**

Associated Masterformat Sections: 01 82 16 / 01 82 16 / 01 82 16 / 01 82 16

100	Solid mass model representing overall building volume; or, schematic wall elements that are not distinguishable by type or material. Assembly depth/thickness and locations still flexible.	
200	Element modeling to include: <ul style="list-style-type: none"> • Approximate size and shape of the subgrade enclosure element. • Structural building grids for local project coordinate system are defined in model and coordinated with global civil coordinate system (State Plane Coordinate System, etc). Suggested Baseline Attributes <ul style="list-style-type: none"> • Member Type 	

A2010 21-01 20 10 Walls for Subgrade Enclosures

Includes: Perimeter walls enclosing building space below grade. Includes formwork, reinforcing, concrete and masonry. Includes Subgrade Enclosure Wall Supplementary Components as appropriate. May Include: Related Activities: Excavation, dewatering, excavation support systems, backfill and compaction, and soil treatment.

Associated Masterformat Sections:

100	See A20	
200	See A20	
300	Element modeling to include: <ul style="list-style-type: none"> • Overall size and geometry of the subgrade element • Sloping surfaces • External dimensions of the element 	
350	Element modeling to include: <ul style="list-style-type: none"> • Chamfers • Sleeve penetrations • Pour joints • Rebar and any embedded elements modeled at congested areas where specified by project BIMXP which is typically within a set distance from the area of congestion. • Any permanent shoring or forming structures such as void boxes • insulation • Expansion joints • Moisture retarder • Exposed embeds or reinforcement such as lintels • Penetrations detailed and modeled • Expansion joints 	

Reference Part II Attribute Tables for non-graphical information

400	Element modeling to include: <ul style="list-style-type: none"> • Rebar including hooks and lap splices • Dowels • Chamfer • Coursing for unit masonry defined • Waterproofing 	
-----	---	--

A2010.10	21-01 20 10 10	Subgrade Enclosure Wall Construction	TBD
A2010.20	21-01 20 10 20	Subgrade Enclosure Wall Interior Skin	TBD
A2010.90	21-01 20 10 90 TBD	Subgrade Enclosure Wall Supplementary Components	

A40 21-01 40 Slabs-on-Grade

Associated Masterformat Sections: 01 82 00

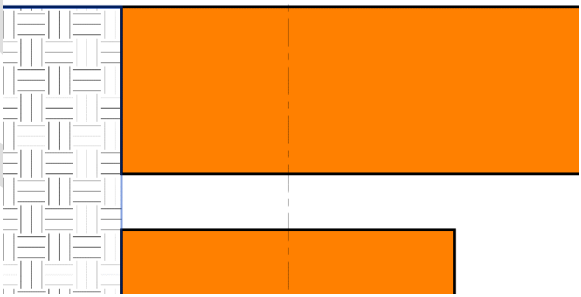
100	Assumptions for slabs are included in other modeled elements such as a volumetric mass or architectural floor element that contains a layer for assumed structural framing depth.	
200	Element modeling to include <ul style="list-style-type: none"> • Generic slab with approximate thickness. • Structural building grids for local project coordinate system are defined in model and coordinated with global civil coordinate system (State Plane Coordinate System, etc.) 	 <p>14 A40-LOD-200 Slabs-on-Grade</p>

A4010 21-01 40 10 Standard Slabs-on-Grade

Includes: Slab construction supported continuously by earth or compacted fill. Includes fine grading, subbase layer, mud slab, insulation, vapor retarder, waterproofing, formwork, expansion joints, control joints, reinforcement, concrete, and finishing includes: Slabs-On-Grade Supplementary Components as appropriate. May Include: Related Activities: Excavation, dewatering, excavation support systems, backfill and compaction, and soil treatment.

Associated Masterformat Sections: 03 30 00

100	See A40	
200	See A40	

Reference Part II Attribute Tables for non-graphical information

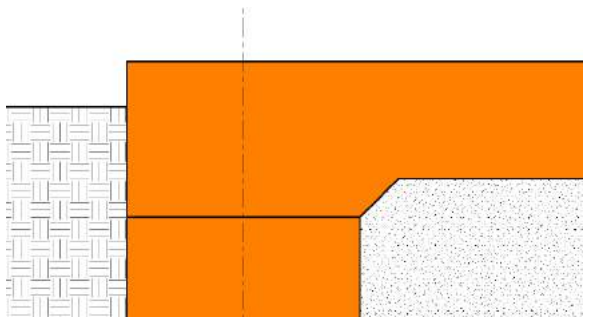
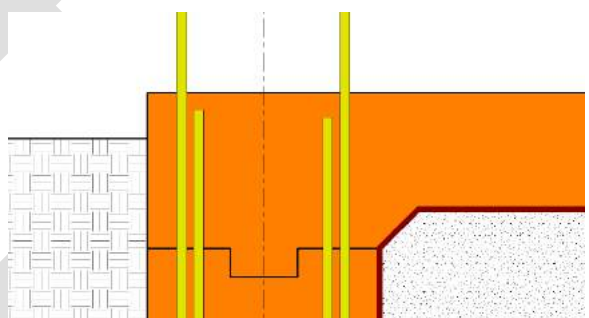
<p>300</p>	<p>Element modeling to include:</p> <ul style="list-style-type: none"> • Overall size, thickness and geometry of the slab • Slab depressions • Edge turn downs • Material strength • Surfaces modeled to actual slopes 	 <p>15 A4010-LOD-300 Standard Slabs-on-Grade</p>
<p>350</p>	<p>Element modeling to include:</p> <ul style="list-style-type: none"> • Sleeve penetrations • Pour joints • Control joints • Expansion joints • Water stops • Rebar and any embedded elements modeled at congested areas where specified by project BIMXP which is typically within a set distance from the area of congestion. • Void boxes • Anchor rods • Dowels • Post-tension profile and strands if required by the BIMXP. 	 <p>16 A4010-LOD-350 Standard Slabs-on-Grade</p>
<p>400</p>	<p>Element modeling to include:</p> <ul style="list-style-type: none"> • Actual slab dimensions and profiles with fully modeled rebar • Post tensioning components • All joints • Water proofing • Finish 	

A4020 21-01 40 20 Structural Slabs-on-Grade

Includes: Self-supporting slab construction not supported continuously by earth or compacted fill. Includes formwork, accessories, reinforcement, concrete, and finishing. Includes Slabs-On-Grade Supplementary Components as appropriate. May Include: Related Activities: Excavation, dewatering, excavation support systems, backfill and compaction, and soil treatment.

Associated Masterformat Sections: 03 30 00

<p>100</p>	<p>See A40</p>	
<p>200</p>	<p>See A40</p>	

Reference Part II Attribute Tables for non-graphical information

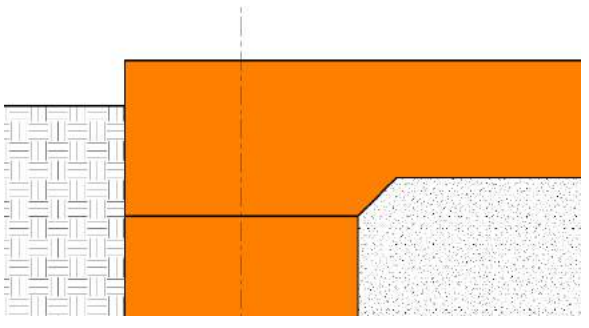
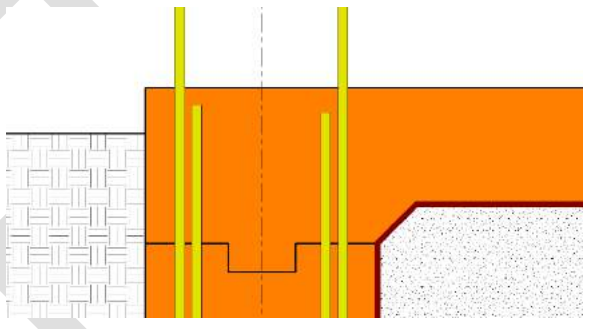
<p>300</p>	<p>Element modeling to include:</p> <ul style="list-style-type: none"> • Overall size, thickness and geometry of the slab-on-grade • Main openings such as elevators and other shafts greater than or equal to 12" in any dimension • Slab depressions • Edge turn downs • All sloping surfaces included in model element with exception of elements affected by manufacturer selection which are not known at this LOD. Such conditions could include floor geometry differences where different <u>specified</u> manufacturers will not be known until the <u>actual</u> system is selected. 	 <p><i>17 A4020-LOD-300 Structural Slabs-on-Grade</i></p>
<p>350</p>	<p>Element modeling to include:</p> <ul style="list-style-type: none"> • All sleeve penetrations and MEP openings • Pour joints • Control joints • Expansion joints • Water Stops • Rebar and any embedded elements modeled at congested areas where specified by project BIMXP which is typically with in a set distance from the area of congestion. • Void boxes • Anchor rods • Moisture retarder • Dowels • Post-tension profile and strands modeled if required by the BIMXP 	 <p><i>18 A4020-LOD-350 Structural Slabs-on-Grade</i></p>
<p>400</p>	<p>Element modeling to include:</p> <ul style="list-style-type: none"> • Fully modeled rebar • Post tensioning components • All joints • Water proofing 	

Uniformat

Omniclass

Reference Part II Attribute Tables for non-graphical information

A4030	21-01-40-30	Slab Trenches	TBD
A4040	21-01-40-40	Pits and Bases	TBD
A4090	21-01-40-90	Slab-On-Grade Supplementary Components	TBD
A60	21-01-60	Water and Gas Mitigation	TBD
A6010	21-01-60-10	Building Subdrainage	TBD
A6020	21-01-60-20	Off-Gassing Mitigation	TBD
A90	21-01-90	Substructure Related Activities	TBD
A9010	21-01-90-10	Substructure Excavation	TBD
A9020	21-01-90-20	Construction Dewatering	TBD
A9030	21-01-90-30	Excavation Support	TBD
A9040	21-01-90-40	Soil Treatment	TBD

Reference Part II Attribute Tables for non-graphical information

B 21-02 00 00 SHELL

Associated Masterformat Sections: 01 83 00

B10 21-02 10 Superstructure

Associated Masterformat Sections: 01 83 13

100	Assumptions for structural framing are included in other modeled elements such as an architectural floor element that contains a layer for assumed structural framing depth; or, schematic structural elements that are not distinguishable by type or material. Assembly depth/thickness or component size and locations still flexible.	
-----	--	--

B1010 21-02 10 10 Floor Construction

Associated Masterformat Sections: 01 83 13

100	See B10	
200	Model elements to include: <ul style="list-style-type: none"> • Floor with approximate dimensions • Approximate supporting framing members • Structural grids defined accurately 	

B1010.10 21-02 10 10 10 Floor Structural Frame

Includes: Structural elements required for support of floor construction within basements and above grade. Includes columns, girders, beams, trusses, joists. Includes cast-in-place concrete, precast concrete, unit masonry, metal framed, and wood framed systems. Includes framed and sleeved openings for services. Includes Floor Construction Supplementary Components as appropriate.

Specific structural systems within this section are listed as follows:

- [Concrete](#)
- [Masonry](#)
- [Steel Framing Columns](#)
- [Steel Framing Beams](#)
- [Steel Framing Bracing Rods](#)
- [Steel Joists](#)
- [Cold-Formed Metal Framing](#)
- [Wood Floor Trusses](#)

Associated Masterformat Sections: 03 30 00 / 03 40 00 / 04 20 00 / 05 10 00 / 05 20 00
05 21 23 / 05 42 00 / 05 44 00 / 06 11 00 / 06 13 00 / 06 13 26 / 06 17 33 / 06 17 36
06 17 53 / 06 18 13 / 06 18 16 / 06 50 00

Reference Part II Attribute Tables for non-graphical information

B1010.10.10 21-02 10 10 10 Floor Structural Frame (Concrete)

Associated Masterformat Sections: 03 30 00 / 03 40 00

100	See B10	
200	<p>Element modeling to include:</p> <ul style="list-style-type: none"> • Type of structural concrete system • Approximate geometry (e.g. depth) of structural elements 	
300	<p>Element modeling to include:</p> <ul style="list-style-type: none"> • Composite model assembly by type with overall thickness that accounts for framing and finish specified for the wall system. (Refer to LOD350 and LOD400 for individually modeled elements) • Specific sizes and locations of main concrete structural members modeled per defined structural grid with correct orientation • Concrete defined per spec (strength, air entrainment, aggregate size, etc.) • All sloping surfaces included in model element with exception of elements affected by manufacturer selection 	
350	<p>Element modeling to include:</p> <ul style="list-style-type: none"> • Reinforcing Post-tension profiles and strand locations • Reinforcement called out, modeled if required by the BIMXP, typically only in congested areas • Pour joints and sequences to help identify reinforcing lap splice locations, scheduling, etc. • Expansion Joints • Embeds and anchor rods • Post-tension profile and strands modeled if required by the BIMXP • Penetrations for items such as MEP • Any permanent forming or shoring components • Shear reinforcing and stud rails • Critical structural zones for coordination, including but not limited to zones that cannot be penetrated, cut, or damaged 	
400	<p>Element modeling to include:</p> <ul style="list-style-type: none"> • All reinforcement including post tension elements detailed and modeled camber, chamfer, etc. 	

Reference Part II Attribute Tables for non-graphical information

B1010.10.20 21-02 10 10 10

Floor Structural Frame (Masonry)

Associated Masterformat Sections: 04 20 00

100	See B10	
200	Element modeling to include: <ul style="list-style-type: none"> Type of structural masonry system 	
300	Element modeling to include: <ul style="list-style-type: none"> Specific sizes of main structural elements modeled per defined structural grid with correct dimensions Rough openings with reinforcement and lintels called out 	
350	Element modeling to include: <ul style="list-style-type: none"> Actual location and shape of structural masonry element All exposed embeds or reinforcement such as lintels All penetrations detailed and modeled Expansion joints Grouted cell locations 	
400	Element modeling to include: <ul style="list-style-type: none"> Waterproofing Coursing Reinforcing 	

Reference Part II Attribute Tables for non-graphical information

B1010.10.30 21-02 10 10 10 Floor Structural Frame (Steel Framing Columns)

Associated Masterformat Sections: 05 10 00

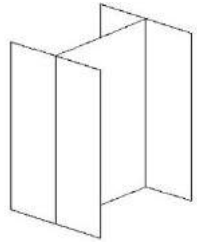
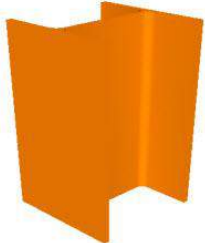
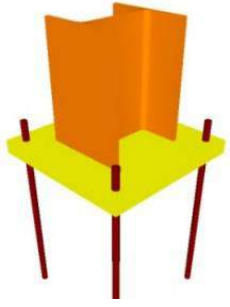
<p>100</p>	<p>Generic column element, See B10.</p>	 <p><i>19 B1010.10-LOD-100 Floor Structural Frame (Steel Framing Columns)</i></p>
<p>200</p>	<p>See B101010</p>	 <p><i>20 B1010.10-LOD-200 Floor Structural Frame (Steel Framing Columns)</i></p>
<p>300</p>	<p>Element modeling to include:</p> <ul style="list-style-type: none"> • Specific sizes of main vertical structural members modeled per defined structural grid with correct location and orientation 	 <p><i>21 B1010.10-LOD-300 Floor Structural Frame (Steel Framing Columns)</i></p>
<p>350</p>	<p>Element modeling to include:</p> <ul style="list-style-type: none"> • Actual elevations and location of member connections • Main elements of typical connections applied to all structural steel connections such as base plates, gusset plates, anchor rods, etc. • Any miscellaneous steel members with correct orientation • Any steel structure reinforcement such as web stiffeners, sleeve penetrations, etc. 	 <p><i>22 B1010.10-LOD-350 Floor Structural Frame (Steel Framing Columns)</i></p>

Reference Part II Attribute Tables for non-graphical information

400	Element modeling to include: <ul style="list-style-type: none">• Welds• Coping of members• Cap plates• Washers, nuts, etc.• All assembly elements	 <p data-bbox="971 659 1533 716"><i>23 B1010.10-LOD-400 Floor Structural Frame (Steel Framing Columns)</i></p>
-----	---	---

DRAFT

Reference Part II Attribute Tables for non-graphical information

B1010.10.40 21-02 10 10 10 Floor Structural Frame (Steel Framing Beams)

Associated Masterformat Sections: 05 10 00 / 05 20 00 / 05 21 23

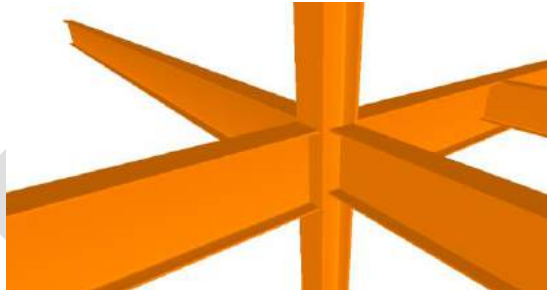
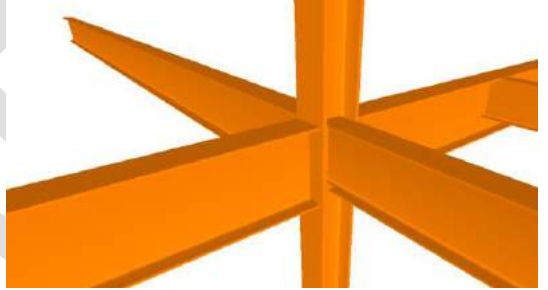
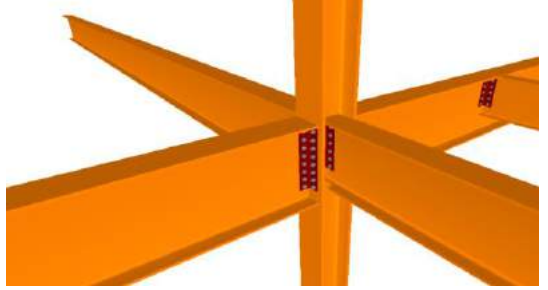
100	See B10	
200	See B1010	
300	<p>Element modeling to include:</p> <ul style="list-style-type: none"> • Specific sizes of main horizontal structural members modeled per defined structural grid with correct orientation, slope and elevation • 	 <p><i>24 B1010.10-LOD-300 Floor Structural Frame (Steel Framing Beams)</i></p>
350	<p>Element modeling to include:</p> <ul style="list-style-type: none"> • Actual elevations and location of member connections • Main elements of typical connections applied to all structural steel connections such as base plates, gusset plates, anchor rods, etc. • Any miscellaneous steel members with correct orientation • Any steel structure reinforcement such as web stiffeners, sleeve penetrations, etc. 	 <p><i>25 B1010.10-LOD-350 Floor Structural Frame (Steel Framing Beams)</i></p>
400	<p>Element modeling to include:</p> <ul style="list-style-type: none"> • Welds • Coping of members • Bent plates, cap plates, etc. • Bolts, washers, nuts, etc. • All assembly elements 	 <p><i>26 B1010.10-LOD-400 Floor Structural Frame (Steel Framing Beams)</i></p>

Reference Part II Attribute Tables for non-graphical information

B1010.10.50 21-02 10 10 10

Floor Structural Frame (Steel Framing Bracing Rods)

Associated Masterformat Sections: 05 10 00

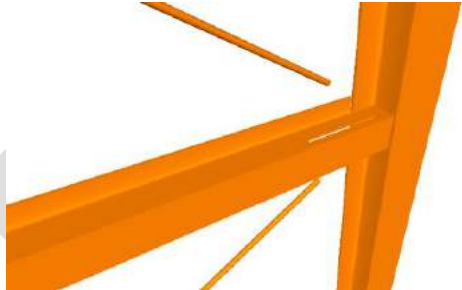
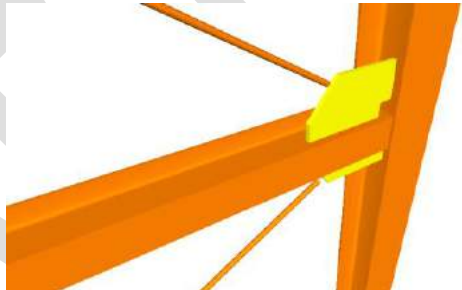
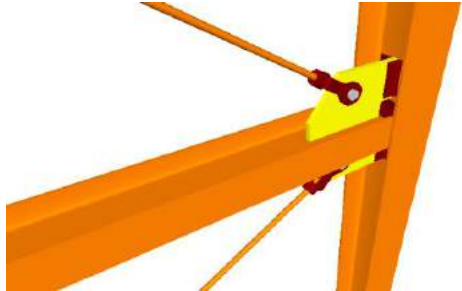
100	See B10	
200	See B1010	
300	<p>Element modeling to include:</p> <ul style="list-style-type: none"> • Specific sizes of main structural braces modeled per defined structural grid 	 <p>27 B1010.100-LOD-300 Floor Structural Frame (Steel Framing Bracing Rods)</p>
350	<p>Element modeling to include:</p> <ul style="list-style-type: none"> • Connection details • Actual elevations and location of member connections • Main elements of typical connections applied to all structural steel connections such as base plates, gusset plates, anchor rods, etc. • Any miscellaneous steel members with correct orientation 	 <p>28 B1010.100-LOD-350 Floor Structural Frame (Steel Framing Bracing Rods)</p>
400	<p>Element modeling to include:</p> <ul style="list-style-type: none"> • Welds • Clevis • Bolts, washers, nuts, etc. • All assembly elements 	 <p>29 B1010.100-LOD-400 Floor Structural Frame (Steel Framing Bracing Rods)</p>

Reference Part II Attribute Tables for non-graphical information

B1010.10.60 21-02 10 10 10 Floor Structural Frame (Steel Joists)

Associated Masterformat Sections: 05 10 00 / 05 20 00 / 05 21 23

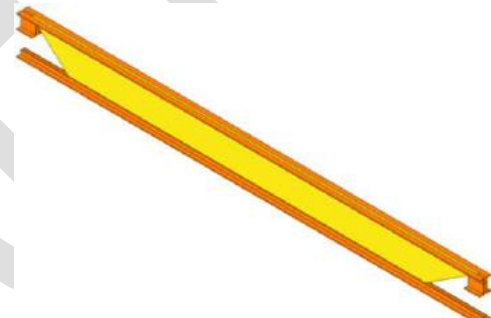
100	See B10	
200	<p>Element modeling to include:</p> <ul style="list-style-type: none"> • Approximate depth 	 <p><i>30 B1010.10-LOD-200 Floor Structural Frame (Steel Joists)</i></p>
300	<p>Element modeling to include:</p> <ul style="list-style-type: none"> • Joist size, depth, slope, and material • Spacing and end elevations • Joist seat depth • 	 <p><i>31 B1010.10-LOD-300 Floor Structural Frame (Steel Joists)</i></p>

Reference Part II Attribute Tables for non-graphical information

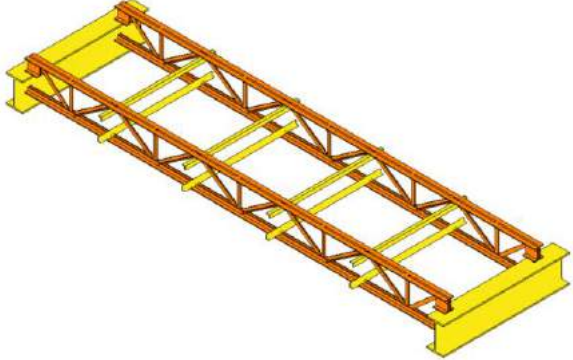
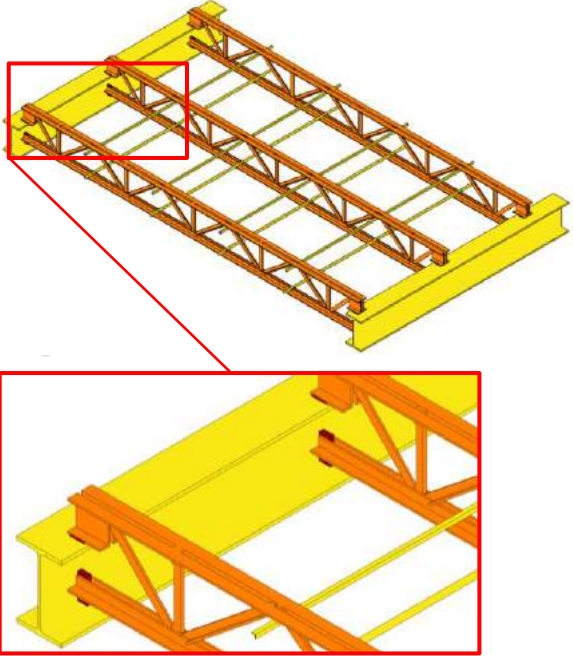
<p>350</p>	<p>Element modeling to include, information needed for cross trade collaboration such as:</p> <ul style="list-style-type: none"> • Actual final joist profile locations with accurate panel points • Joist bridging and lateral braces. • Fire protection coating • Any miscellaneous steel pertaining to the joist • Joist seat width • Erection details for installation • Chord and web member section profiles are defined • Joist layout in coordination with metal deck fasteners would be confirmed • Non-standard joist seat depths and/or sloping joist seat 	 <p>32 B1010.10-LOD-350 Floor Structural Frame (Steel Joists)</p>
<p>400</p>	<p>Element modeling to include:</p> <ul style="list-style-type: none"> • Welds • Connection plates • Member fabrication part number • Quantity • Spacing • Anchorage • Material required for proper installation • Mark identification that correlates with bill of material <p>Type of shop paint if required</p>	 <p>33 B1010.10-LOD-400 Floor Structural Frame (Steel Joists)</p>

Reference Part II Attribute Tables for non-graphical information

B1010.10.70 21-02 10 10 10 Floor Structural Frame (Cold-Formed Metal Framing)

Associated Masterformat Sections: 05 10 00 / 05 42 00 / 05 44 00

100	See B10	
200	Element modeling to include: <ul style="list-style-type: none"> • Rough architectural masses • Approximate member depth • Desired member spacing 	
300	Element modeling to include: <ul style="list-style-type: none"> • floor element with design-specified locations and geometries 	
350	Element modeling to include: <ul style="list-style-type: none"> • Members modeled at any interface with wall edges (top, bottom, sides) or opening through wall • Bridging or straps 	
400	Element modeling to include: <ul style="list-style-type: none"> • Welds • Connections • Member fabrication part number • Any part required for complete installation 	

Reference Part II Attribute Tables for non-graphical information

B1010.10

21-02 10 10 10

Floor Structural Frame (Masonry Framing)

Includes: Structural elements required for support of floor construction within basements and above grade. Includes columns, girders, beams, trusses, joists. Includes cast-in-place concrete, precast concrete, unit masonry, metal framed, and wood framed systems. Includes framed and sleeved openings for services. Includes Floor Construction Supplementary Components as appropriate.

Associated Masterformat Sections: 04 20 00

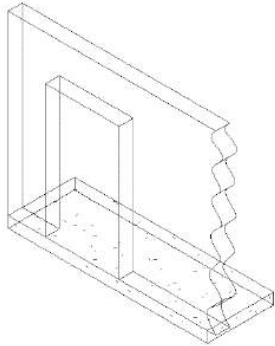
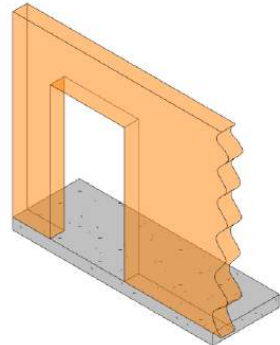
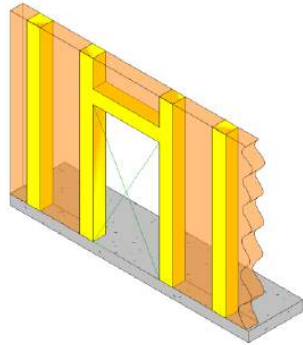
100	See B10	
200	See B10	 <p>34 B1010.10-LOD-200 Floor Structural Frame (Masonry Framing)</p>
300	<p>Element modeling to include:</p> <ul style="list-style-type: none"> • floor element with design-specified locations and geometries 	 <p>35 B1010.10-LOD-300 Floor Structural Frame (Masonry Framing)</p>
350	<p>Element modeling to include:</p> <ul style="list-style-type: none"> • Members modeled at any interface with wall edges (top, bottom, sides) or opening through wall • Any regions that would impact coordination with other systems such as but not limited to: <ul style="list-style-type: none"> ○ Bond Beam & Lintel Regions ○ Reinforcing & Embed Regions ○ Jam Regions ○ Any other grouted regions 	 <p>36 B1010.10-LOD-350 Floor Structural Frame (Masonry Framing)</p>

Reference Part II Attribute Tables for non-graphical information

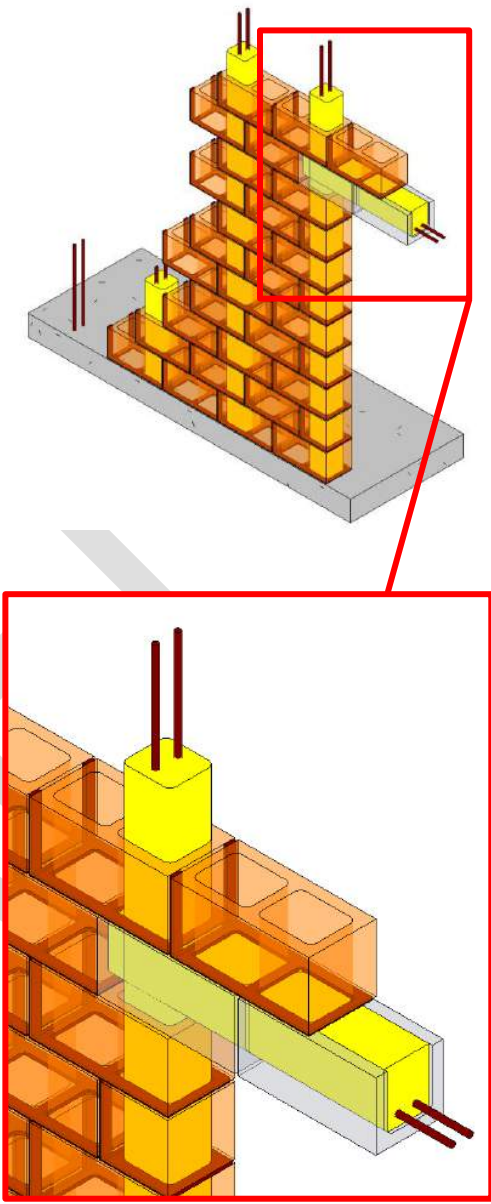
400	<p>Element modeling to include:</p> <ul style="list-style-type: none">• Reinforcing• Connections• Grouting Material• Jams• Bond Beams• Lintels• Member fabrication part number• Any part required for complete installation	 <p>The image shows a 3D perspective view of a masonry wall structure. The wall is composed of orange-colored masonry blocks. A yellow cylindrical component is shown protruding from the top of the wall, with two vertical brown rods (rebar) passing through it. A red callout box highlights a specific detail of the wall's construction, showing a yellow rectangular component (likely a lintel or bond beam) integrated with the masonry blocks. This component has two horizontal brown rods (rebar) extending from its ends. The entire structure is supported by a grey base.</p> <p><i>37 B1010.10-LOD-400 Floor Structural Frame (Masonry Framing)</i></p>
-----	--	--

Reference Part II Attribute Tables for non-graphical information

B1010.10.80 21-02 10 10 10 Floor Structural Frame (Wood Floor Trusses)

Associated Masterformat Sections: 06 11 00 / 06 13 26 / 06 17 53

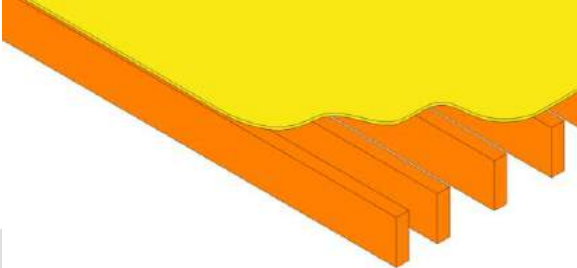
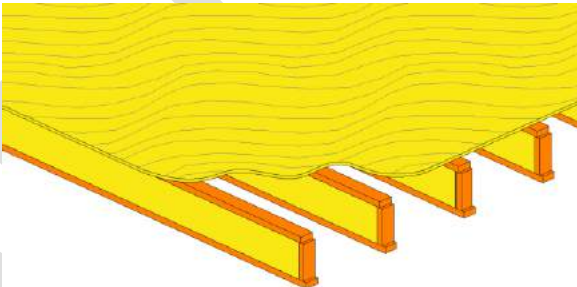
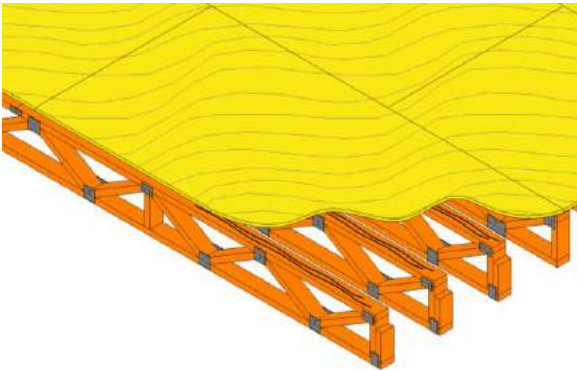
100	See B10	
200	<p>Element modeling to include:</p> <ul style="list-style-type: none"> • Approximate depth • Top chord or bottom chord bearing • Truss orientation • Approximate depth • Approximate width • Truss orientation • Approximate centerline location of individual trusses 	 <p><i>38 B1010.10-LOD-200 Floor Structural Frame (Wood Floor Trusses)</i></p>
300	<p>Element modeling to include:</p> <ul style="list-style-type: none"> • Truss size, depth, and material with sloping geometry • Spacing and end elevations • Support locations 	 <p><i>39 B1010.10-LOD-300 Floor Structural Frame (Wood Floor Trusses)</i></p>
350	<p>Element modeling to include:</p> <ul style="list-style-type: none"> • Actual final truss profile with accurate panel points • Bridging and lateral braces • Fire protection coating • Any miscellaneous framing pertaining to the truss • Erection details for installation • Chord and web member section profiles are accurately defined • Truss layout in coordination with deck fasteners would be confirmed • Hold down locations for large bolts. 	 <p><i>40 B1010.10-LOD-350 Floor Structural Frame (Wood Floor Trusses)</i></p>

Reference Part II Attribute Tables for non-graphical information

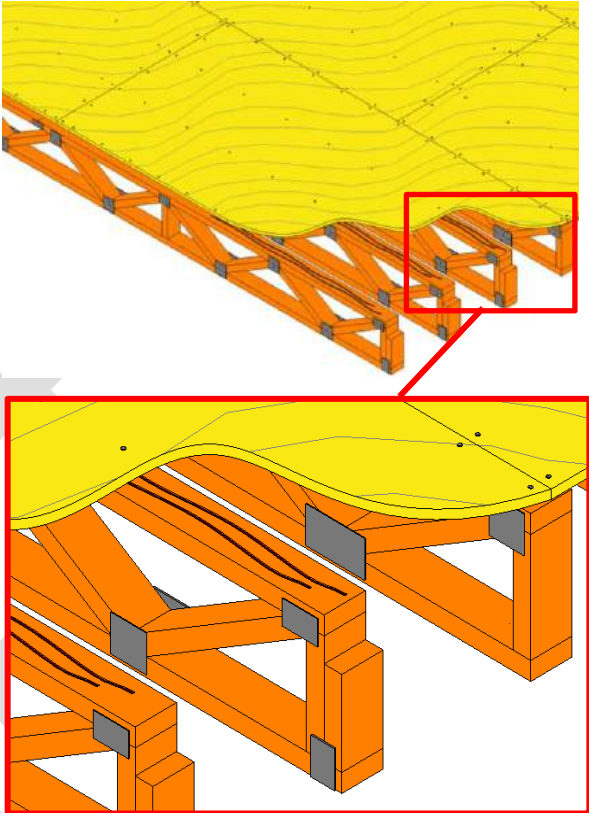
<p>400</p>	<p>Element modeling to include:</p> <ul style="list-style-type: none">• Fasteners• Sealant• Truss plates and connection material• Nails and fasteners• Truss plates.• Deck patterns and joints	 <p>41 B1010.10-LOD-400 Floor Structural Frame (Wood Floor Trusses)</p>
------------	---	--

Reference Part II Attribute Tables for non-graphical information

B1010.10.90 21-02 10 10 10 Precast Structural Inverted T Beam (Concrete)

Includes: Structural elements required for support of floor construction within basements and above grade. Includes columns, girders, beams, trusses, joists. Includes cast-in-place concrete, precast concrete, unit masonry, metal framed, and wood framed systems. Includes framed and sleeved openings for services. Includes Floor Construction Supplementary Components as appropriate.

*Associated Masterformat Sections: 03 30 00 / 03 40 00 / 04 20 00 / 05 10 00 / 05 20 00
05 21 23 / 05 42 00 / 05 44 00 / 06 11 00 / 06 13 00 / 06 13 26 / 06 17 33 / 06 17 36
06 17 53 / 06 18 13 / 06 18 16 / 06 50 00*

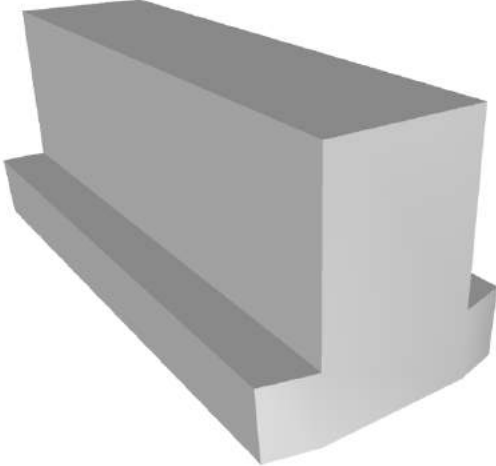
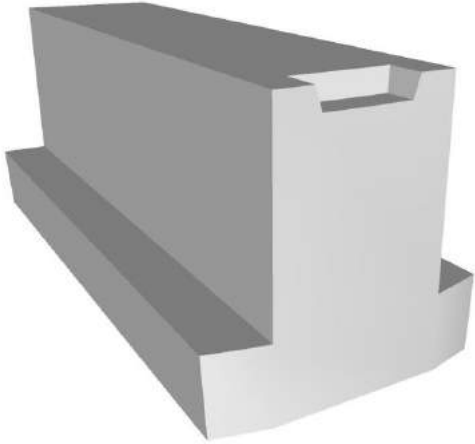
100	See B10	
200	<p>Element modeling to include:</p> <ul style="list-style-type: none"> • Type of structural concrete system • Approximate geometry (e.g. depth) of structural elements 	 <p><i>42 B1010.10-LOD 200 Precast Structural Inverted T Beam (Concrete)</i></p>
300	<p>Element modeling to include:</p> <ul style="list-style-type: none"> • Specific sizes and locations of main concrete structural members modeled per defined structural grid with correct orientation • Concrete defined per spec (strength, air entrainment, aggregate size, etc.) • All sloping surfaces included in model element with exception of elements affected by manufacturer selection 	 <p><i>43 B1010.10-LOD 300 Precast Structural Inverted T Beam (Concrete)</i></p>

Reference Part II Attribute Tables for non-graphical information

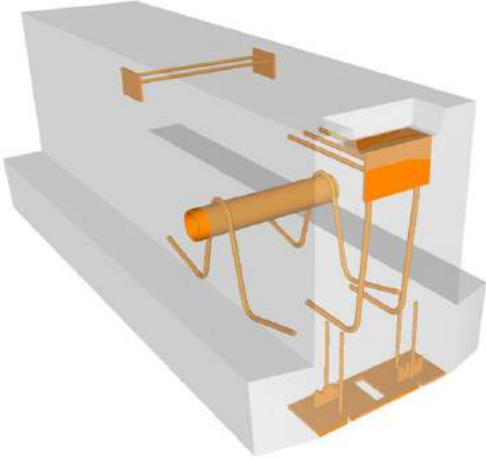
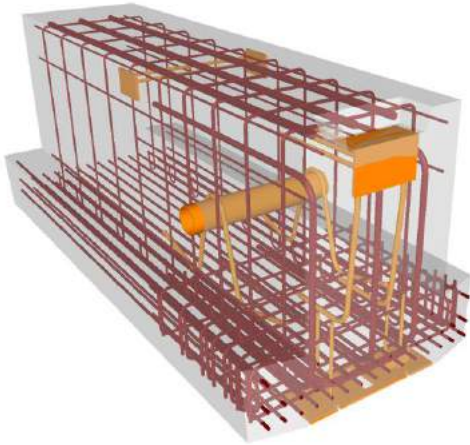
<p>350</p>	<p>Element modeling to include:</p> <ul style="list-style-type: none"> • Reinforcing Post-tension profiles and strand locations • Reinforcement called out, modeled if required by the BIMXP, typically only in congested areas • Pour joints and sequences to help identify reinforcing lap splice locations, scheduling, etc. • Lifting devices • Expansion Joints • Embeds and anchor rods • Post-tension profile and strands modeled if required by the BIMXP • Penetrations for items such as MEP • Any permanent forming or shoring components 	 <p><i>44 B1010.10-LOD 350 Precast Structural Inverted T Beam (Concrete)</i></p>
<p>400</p>	<p>Element modeling to include:</p> <ul style="list-style-type: none"> • All reinforcement including post tension elements detailed and modeled • Finishes, camber, chamfer, etc. 	 <p><i>45 B1010.10-LOD 400 Precast Structural Inverted T Beam (Concrete)</i></p>

Reference Part II Attribute Tables for non-graphical information

B1010.10 21-02 10 10 10 Precast Structural Column (Concrete)

Includes: Structural elements required for support of floor construction within basements and above grade. Includes columns, girders, beams, trusses, joists. Includes cast-in-place concrete, precast concrete, unit masonry, metal framed, and wood framed systems. Includes framed and sleeved openings for services. Includes Floor Construction Supplementary Components as appropriate.

*Associated Masterformat Sections: 03 30 00 / 03 40 00 / 04 20 00 / 05 10 00 / 05 20 00
05 21 23 / 05 42 00 / 05 44 00 / 06 11 00 / 06 13 00 / 06 13 26 / 06 17 33 / 06 17 36
06 17 53 / 06 18 13 / 06 18 16 / 06 50 00*

100	See B10	
200	<p>Element modeling to include:</p> <ul style="list-style-type: none"> • Type of structural concrete system • Approximate geometry (e.g. depth) of structural elements 	 <p><i>46 B1010.10- LOD 200 Precast Structural Column (Concrete)</i></p>

Reference Part II Attribute Tables for non-graphical information

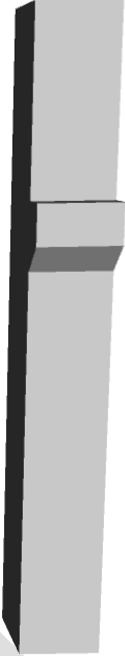
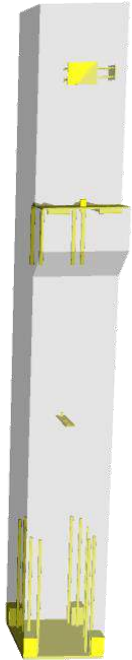
<p>300</p>	<p>Element modeling to include:</p> <ul style="list-style-type: none"> • Specific sizes and locations of main concrete structural members modeled per defined structural grid with correct orientation • Concrete defined per spec (strength, air entrainment, aggregate size, etc.) • All sloping surfaces included in model element with exception of elements affected by manufacturer selection 	 <p><i>47 B1010.10 - LOD 300 Precast Structural Column (Concrete)</i></p>
<p>350</p>	<p>Element modeling to include:</p> <ul style="list-style-type: none"> • Reinforcing Post-tension profiles and strand locations • Reinforcement called out, modeled if required by the BIMXP, typically only in congested areas • Pour joints and sequences to help identify reinforcing lap splice locations, scheduling, etc. • Expansion Joints • Lifting devices • Embeds and anchor rods • Post-tension profile and strands modeled if required by the BIMXP • Penetrations for items such as MEP • Any permanent forming or shoring components 	 <p><i>48 B1010.10 - LOD 350 Precast Structural Column (Concrete)</i></p>

Reference Part II Attribute Tables for non-graphical information

400	<p>Element modeling to include:</p> <ul style="list-style-type: none">• All reinforcement including post tension elements detailed and modeled• Finishes, camber, chamfer, etc.	 <p>49 B1010.10 - LOD 400 Precast Structural Column (Concrete)</p>
-----	--	---

DRAFT

Reference Part II Attribute Tables for non-graphical information

B1010.20 21-02 10 10 20 Floor Decks, Slabs, and Toppings

Includes: Structural slab, deck, and sheathing floor construction at intermediate floors of basement construction and above grade.

Includes cast-in-place concrete, precast concrete, cementitious decks and toppings, metal decking, wood sheathing, and wood decking.

Includes framed and sleeved penetrations for services and housekeeping pads for equipment. Includes Floor Construction

Supplementary Components as appropriate.

Specific structural systems within this section are listed as follows:

- [Wood Floor Deck](#)
- [Metal Floor Deck](#)
- [Composite Floor Deck](#)
- [Concrete](#)

Associated Masterformat Sections: 03 30 00 / 03 40 00 / 03 50 00 / 05 30 00 / 05 34 00

05 35 00 / 06 12 00 / 06 15 00 / 06 16 00 / 06 18 00 / 06 53 00 / 06 73 00

B1010.20.10 21-02 10 10 20 Floor Decks, Slabs, and Toppings (Wood Floor Deck)

Associated Masterformat Sections: 06 12 00 / 06 15 00 / 06 16 00 / 06 18 00

100	See B10	
200	See B10	
300	Element modeling to include: <ul style="list-style-type: none"> • Applicable slopes • Expected framing member profiles, spacing, and material 	
350	Element modeling to include: <ul style="list-style-type: none"> • Deck edge location • Actual framing member and location per manufacture • All miscellaneous framing including braces, kickers, etc. • Deck openings modeled with support framing around openings • Point load locations • Actual opening locations and sizes defined 	
400	Element modeling to include: <ul style="list-style-type: none"> • All framing accessory and fasteners modeled per expected installation • Waterproofing 	

Reference Part II Attribute Tables for non-graphical information**B1010.20.20 21-02 10 10 20 Floor Decks, Slabs, and Toppings (Metal Floor Deck)**

Associated Masterformat Sections: 05 30 00 / 05 34 00 / 05 35 00

100	See B10	
200	See B10	
300	<p>Element modeling to include:</p> <ul style="list-style-type: none"> • Deck thickness • Specific Framing member profiles, spacing, and material • Opening locations are prescriptively defined with notes for additional miscellaneous framing • Point load locations 	
350	<p>Element modeling to include:</p> <ul style="list-style-type: none"> • Deck edge location • Deck splice and end lap locations • Actual deck profile and flute locations per manufacturer • All miscellaneous framing including braces, kickers, etc. • Deck openings modeled with support framing 	
400	<p>Element modeling to include:</p> <ul style="list-style-type: none"> • All framing accessory and fasteners modeled per expected installation • Welds • Waterproofing 	

Reference Part II Attribute Tables for non-graphical information

B1010.20.30 21-02 10 10 20

Floor Decks, Slabs, and Toppings (Composite Floor Deck)

Associated Masterformat Sections: 06 73 00

100	See B10	
200	See B10	
300	<p>Element modeling to include:</p> <ul style="list-style-type: none"> • Specific deck thickness • Specific Framing member profiles, spacing, material • Opening locations are prescriptively defined with notes for additional miscellaneous framing 	
350	<p>Element modeling to include:</p> <ul style="list-style-type: none"> • Deck edge location • Actual deck profile and flute locations per manufacture • Deck splice and end lap locations • Actual framing member and location per manufacture • All miscellaneous framing including deck support, deck closure, shear studs, etc. • Slab openings modeled with support framing around openings • Point load locations • Slab reinforcing modeled if specified in BIMXP 	
400	<p>Element modeling to include:</p> <ul style="list-style-type: none"> • All framing accessory and fasteners modeled per expected installation • All slab reinforcing • Welds • Waterproofing 	

Reference Part II Attribute Tables for non-graphical information

B1010.20.40 21-02 10 10 20 Floor Decks, Slabs, and Toppings (Concrete)

Associated Masterformat Sections: 03 30 00 / 03 40 00 / 03 50 00

100	See B10	
200	<p>Element modeling to include:</p> <ul style="list-style-type: none"> • Type of structural concrete system • Approximate geometry (e.g. depth) of structural elements 	
300	<p>Element modeling to include:</p> <ul style="list-style-type: none"> • Specific sizes and locations of main concrete structural members modeled per defined structural grid with correct orientation • All sloping surfaces included in model element with exception of elements affected by manufacturer selection 	
350	<p>Element modeling to include:</p> <ul style="list-style-type: none"> • Reinforcement called out, modeled if required by the BIMXP, typically only in congested areas • Pour joints and sequences to help identify reinforcing lap splice locations, scheduling, etc. • Expansion Joints • Embeds and anchor rods • Post-tension profile and strands modeled if required by the BIMXP • Penetrations for items such as MEP • Any permanent forming or shoring components • Shear reinforcing and stud rails 	

Reference Part II Attribute Tables for non-graphical information

400	Element modeling to include:	
	<ul style="list-style-type: none"> All reinforcement including post tension elements detailed and modeled camber, chamfer, etc. 	

B1010.30 21-02 10 10 30 Balcony Floor Construction TBD

B1010.20 21-02 10 10 10 Precast Structural Double Tee (Concrete)
Includes: Structural elements required for support of floor construction within basements and above grade. Includes columns, girders, beams, trusses, joists. Includes cast-in-place concrete, precast concrete, unit masonry, metal framed, and wood framed systems. Includes framed and sleeved openings for services. Includes Floor Construction Supplementary Components as appropriate

Associated Masterformat Sections: 03 30 00 / 03 40 00 / 04 20 00 / 05 10 00 / 05 20 00
 05 21 23 / 05 42 00 / 05 44 00 / 06 11 00 / 06 13 00 / 06 13 26 / 06 17 33 / 06 17 36
 06 17 53 / 06 18 13 / 06 18 16 / 06 50 00

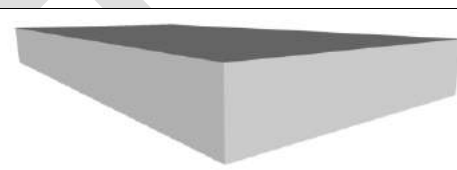
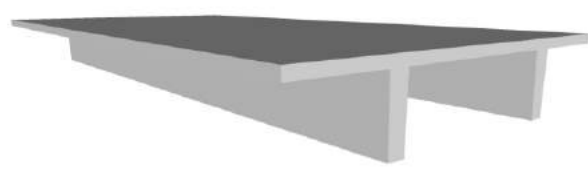
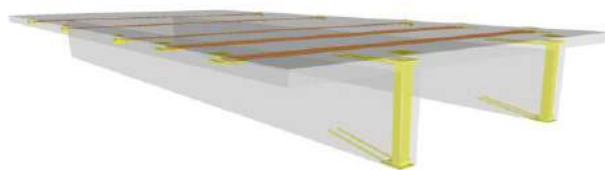
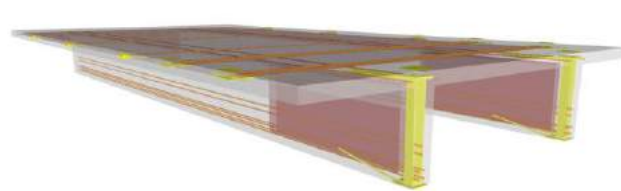
100	See B10	
200	Element modeling to include: <ul style="list-style-type: none"> Type of structural concrete system Approximate geometry (e.g. depth) of structural elements 	 <p>50 B1010.20 – LOD 200 Precast Structural Double Tee (Concrete)</p>
300	Element modeling to include: <ul style="list-style-type: none"> Specific sizes and locations of main concrete structural members modeled per defined structural grid with correct orientation Concrete defined per spec (strength, air entrainment, aggregate size, etc.) All sloping surfaces included in model element with exception of elements affected by manufacturer selection 	 <p>51 B1010.20 – LOD 300 Precast Structural Double Tee (Concrete)</p>
350	Element modeling to include: <ul style="list-style-type: none"> Reinforcing Post-tension profiles and strand locations Reinforcement called out, modeled if required by the BIMXP, typically only in congested areas Pour joints and sequences to help identify reinforcing lap splice locations, scheduling, etc. Expansion Joints Lifting devices Embeds and anchor rods Penetrations for items such as MEP Any permanent forming or shoring components 	 <p>52 B1010.20 – LOD 350 Precast Structural Double Tee (Concrete)</p>
400	Element modeling to include: <ul style="list-style-type: none"> All reinforcement including post tension elements detailed and modeled Finishes, camber, chamfer, etc. 	 <p>53 B1010.20 – LOD 400 Precast Structural Double Tee (Concrete)</p>

Reference Part II Attribute Tables for non-graphical information

B1020 21-02 10 20 Roof Construction

Associated Masterformat Sections: 01 81 13

[See [B1010](#)]

B1020.10 21-02 10 20 10 Roof Structural Frame

Description: Structural elements required for support of floor construction within basements and above grade. Includes columns, girders, beams, trusses, joists. Includes cast-in-place concrete, precast concrete, unit masonry, metal framed, and wood framed systems. Includes framed and sleeved openings for services. Includes Floor Construction Supplementary Components as appropriate.

Associated Masterformat Sections: 03 30 00 / 03 40 00 / 04 20 00 / 05 10 00 / 05 20 00
05 21 23 / 05 42 00 / 05 44 00 / 06 11 00 / 06 13 00 / 06 13 26 / 06 17 33 / 06 17 36
06 17 53 / 06 18 13 / 06 18 16 / 06 50 00

[See [B1010.10](#)]

B1020.20 21-02 10 20 20 Roof Decks, Slabs, and Sheathing

Includes: Structural roof deck, slab, and sheathing construction. Includes cast-in-place concrete, precast concrete, cementitious decks and toppings, metal decking, wood sheathing, wood decking, timber decking and expansion control. Includes framed and sleeved penetrations for services and housekeeping pads for equipment. Includes Roof Construction Supplementary Components as appropriate.

Associated Masterformat Sections: 03 30 00 / 03 40 00 / 03 50 00 / 03 52 00 / 05 30 00
05 34 00 / 05 35 00 / 06 12 00 / 06 15 00 / 06 16 00 / 06 18 00 / 06 53 00 / 06 73 00

[See [B1010.20](#)]

B1020.30 21-02 10 20 30 Canopy Construction

Includes: Structural frame and decks, slabs, and sheathing for canopy construction.

These components are typically modeled as part of other assemblies listed in the tables above. Do not assign this Uniformat classification unless a supplementary component is modeled independently of another assembly.

Associated Masterformat Sections: 03 30 00 / 03 40 00 / 05 10 00 / 05 19 19 / 05 20 00 / 06 11 00 / 06 12 00 / 06 13 00 / 06 15 00 / 06 16 00 / 06 17 00 / 06 18 00 / 06 50 00 / 06 73 00

[See [B1010.20](#)]

Reference Part II Attribute Tables for non-graphical information

B1080 21-02 10 80 Stairs

Includes: Stairs, fire escapes, metal walkways, and ladders.

Associated Masterformat Sections: 01 84 16

100	Assumptions for all stair systems (including railings, fire escapes, walkways, and ladders) are included in other modeled elements such as a spatial or massing element; or, schematic model element that indicates the approximate overall dimensions of the stair layout.
-----	---

B1080.10 21-02 10 80 10 Stair Construction

Includes: Structural framing for exterior and interior stairs including treads, risers, and landings. Includes fire escapes and ladders.

Associated Masterformat Sections: 03 11 23 / 03 30 00 / 03 41 23 / 03 48 19 / 05 51 00

05 55 00 / 05 71 00 / 06 43 00

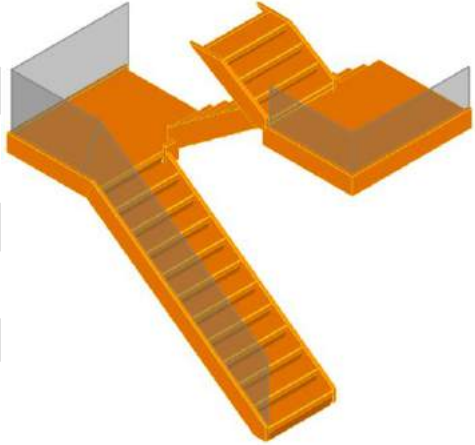
100	See B1080	
200	<p>Generic model element with simplified treads and risers.</p> <p>Nominal overall unit scope shall include:</p> <ul style="list-style-type: none"> • Nominal plan dimensions (length, width) • Nominal vertical dimensions (levels, landings) 	 <p>54 B1080.10-LOD-200 Stair Construction</p>

Reference Part II Attribute Tables for non-graphical information

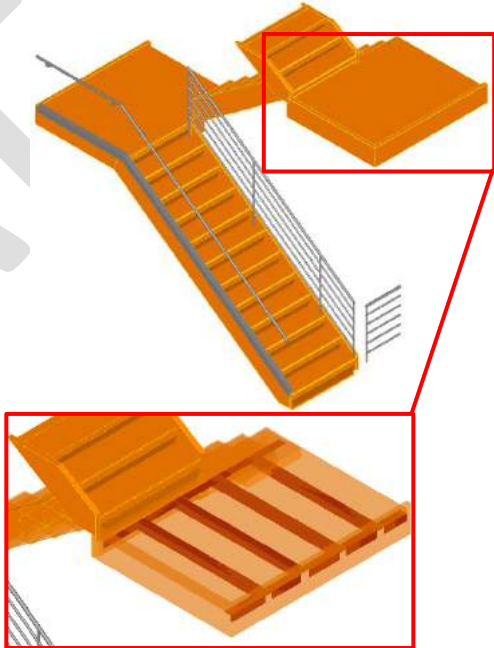
<p>300</p>	<p>Major stair support elements are modeled (stringers). Treads and risers are modeled to indicate design-specified nosing conditions.</p>	 <p>55 B1080.10-LOD-300 Stair Construction</p>
<p>350</p>	<p>Secondary stair support elements are modeled (hangers, brackets, etc.).</p>	 <p>56 B1080.10-LOD-350 Stair Construction</p>

Reference Part II Attribute Tables for non-graphical information

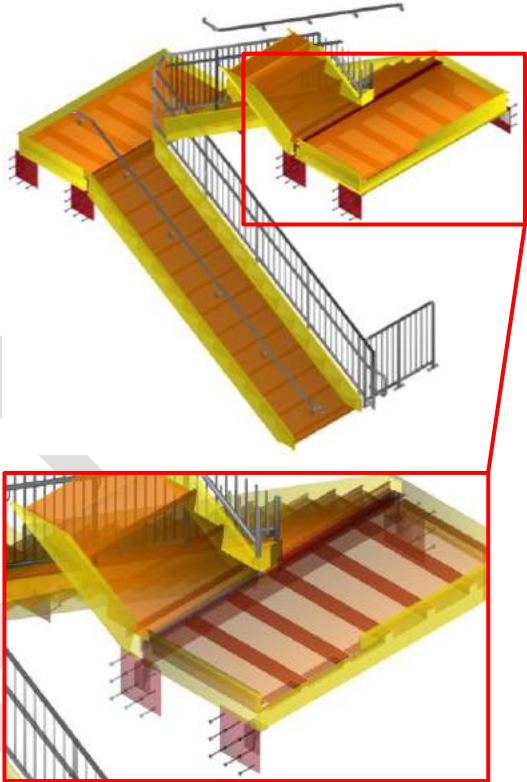
<p>400</p>	<p>All stair elements are modeled to support fabrication and installation.</p>	 <p>57 B1080.10-LOD-400 Stair Construction</p>
------------	--	---

B1080.20 21-02 10 80 10 Precast Structural Stairs (Concrete)
Includes: Structural framing for exterior and interior stairs including treads, risers, and landings. Includes fire escapes and ladders.
 Associated Masterformat Sections: 03 11 23 / 03 30 00 / 03 41 23 / 03 48 19 / 05 51 00
 05 55 00 / 05 71 00 / 06 43 00

<p>100</p>	<p>See B1080</p>	
------------	----------------------------------	--

Reference Part II Attribute Tables for non-graphical information

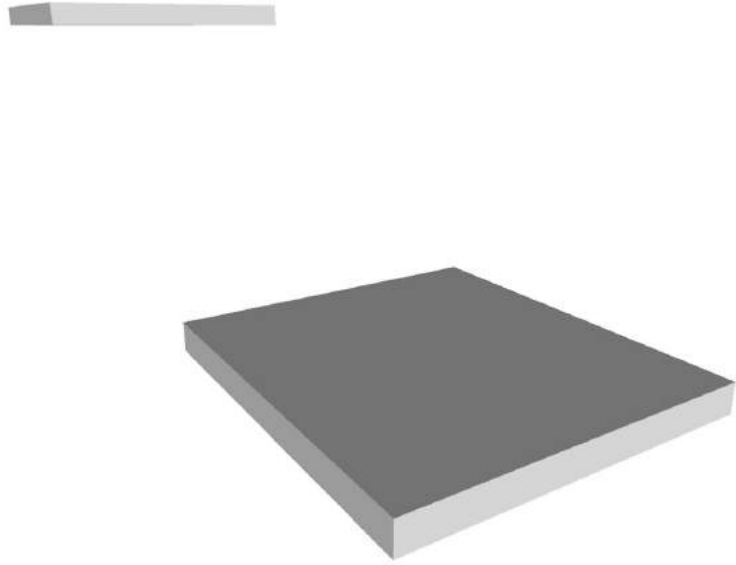
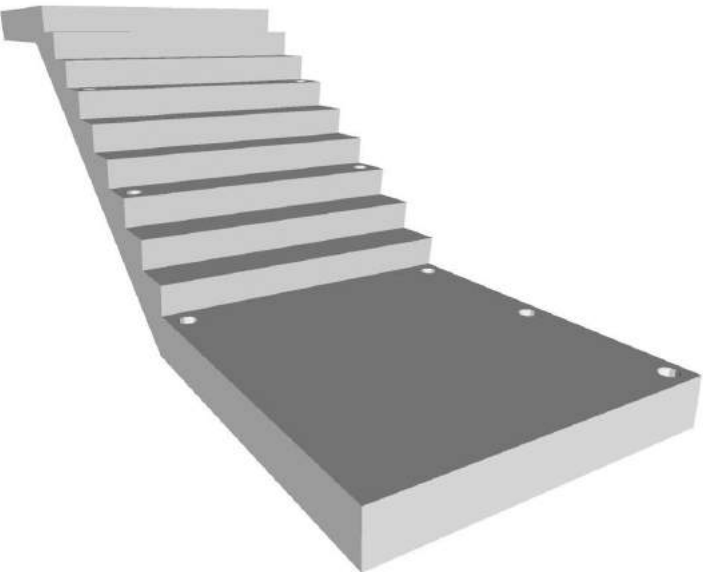
<p>200</p>	<p>Element modeling to include:</p> <ul style="list-style-type: none"> • Type of structural concrete system • Approximate geometry (e.g. depth) of structural elements 	 <p><i>58 B1080.10-LOD 200 Precast Structural Stairs (Concrete)</i></p>
<p>300</p>	<p>Element modeling to include:</p> <ul style="list-style-type: none"> • Specific sizes and locations of main concrete structural members modeled per defined structural grid with correct orientation • Concrete defined per spec (strength, air entrainment, aggregate size, etc.) • All sloping surfaces included in model element with exception of elements affected by manufacturer selection 	 <p><i>59 B1080.10-LOD 300 Precast Structural Stairs (Concrete)</i></p>

Reference Part II Attribute Tables for non-graphical information

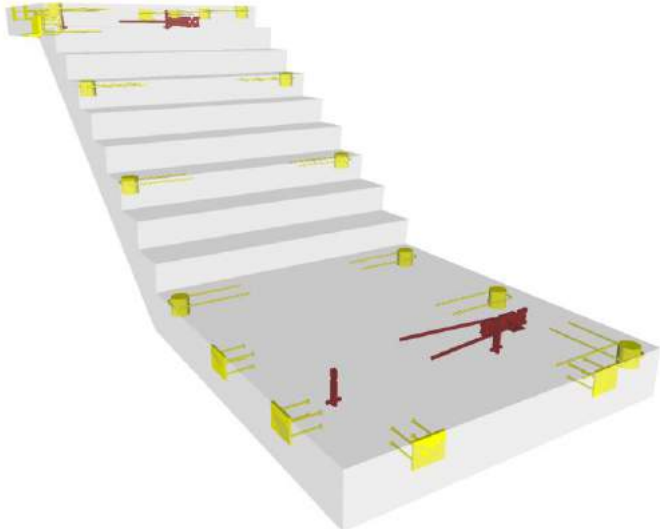
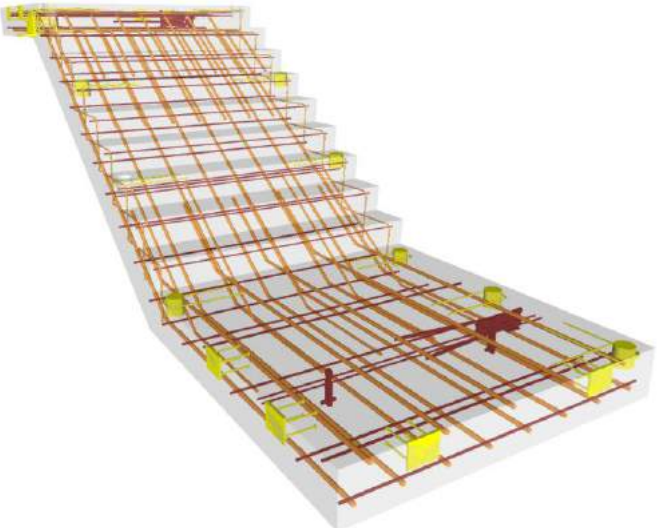
<p>350</p>	<p>Element modeling to include:</p> <ul style="list-style-type: none"> • Reinforcing Post-tension profiles and strand locations • Reinforcement called out, modeled if required by the BIMXP, typically only in congested areas • Pour joints and sequences to help identify reinforcing lap splice locations, scheduling, etc. • Expansion Joints • Lifting devices • Embeds and anchor rods • Post-tension profile and strands modeled if required by the BIMXP • Penetrations for items such as MEP • Any permanent forming or shoring components 	 <p>60 B1080.10-LOD 350 Precast Structural Stairs (Concrete)</p>
<p>400</p>	<p>Element modeling to include:</p> <ul style="list-style-type: none"> • All reinforcement including post tension elements detailed and modeled • Finishes, camber, chamfer, etc. 	 <p>61 B1080.10-LOD 400 Precast Structural Stairs (Concrete)</p>

Reference Part II Attribute Tables for non-graphical information

B1080.50 21-02 10 80 50 Stair Railings

Associated Masterformat Sections: 05 15 00 / 05 52 00 / 05 73 00 / 06 43 16 / 06 63 00
06 81 00

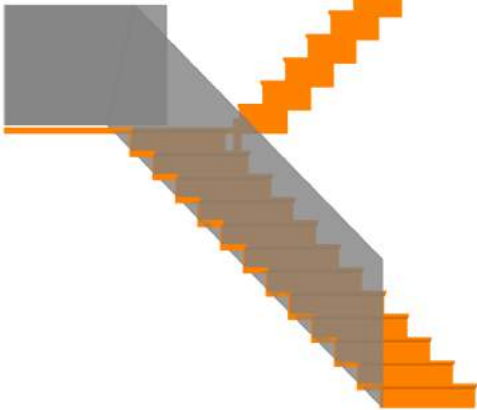
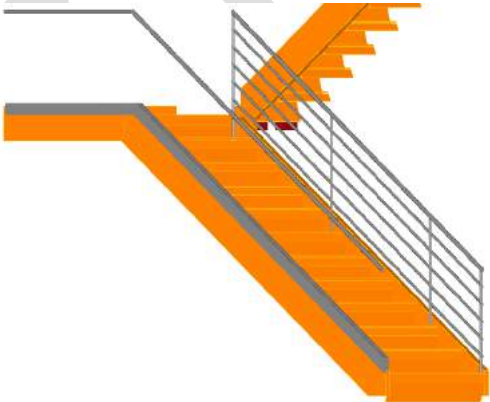
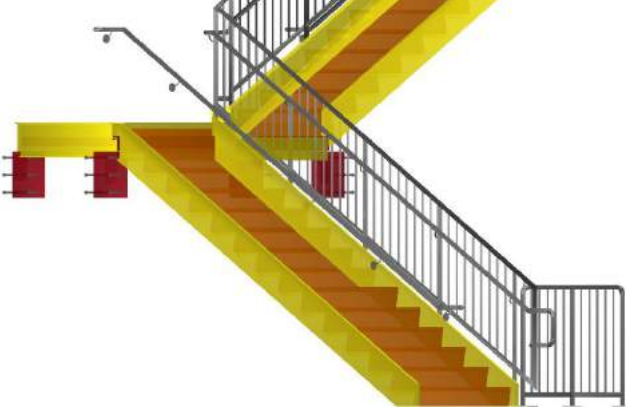
100	See B1080	
200	Generic model elements without articulation of material or railing structure such as balusters, posts, or supports.	 <p>62 B1080.50-LOD-200 Stair Railings</p>
300	Modeled assemblies by type to include: <ul style="list-style-type: none"> • Railings • Balusters • Posts • Supports for wall mounted railings 	 <p>63 B1080.50-LOD-300 Stair Railings</p>
400	[See Fundamental LOD Definitions]	 <p>64 B1080.50-LOD-400 Stair Railings</p>

B1080.60 21-02 10 80 60 Fire Escapes

Associated Masterformat Sections: 05 51 23

Reference Part II Attribute Tables for non-graphical information

[See [B1080.10](#) and [B1080.50](#)]

B1080.70 21-02 10 80 70 **Metal Walkways**

Includes: Catwalks and gratings over horizontal openings

Associated Masterformat Sections: 05 51 36 / 05 51 36.13 / 05 53 00

[See [B1080.10](#) and [B1080.50](#)]

B1080.80 21-02 10 80 80 **Ladders**

Associated Masterformat Sections: 05 51 33 / 05 51 33.13 / 05 51 33.16 / 05 51 33.23

[See [B1080.10](#) and [B1080.50](#)]

DRAFT

Reference Part II Attribute Tables for non-graphical information

B20 21-02 20 Exterior Vertical Enclosures



Associated Masterformat Sections: 01 83 16

100	<p>Solid mass model representing overall building volume; or, schematic wall elements that are not distinguishable by type or material.</p> <p>Assembly depth/thickness and locations still flexible.</p>	
-----	---	--

B2010 21-02 20 10 Exterior Walls

Includes: Exterior Wall Supplementary Components as appropriate. Includes Exterior Wall Opening Supplementary Components as appropriate. Includes: Solid wall construction that is composite in nature; in other words, multiple layers of materials to form an overall assembly.

Associated Masterformat Sections: 01 83 16

100	<p>See B20</p>	
200	<p>Generic wall objects separated by type of material (e.g. brick wall vs. terracotta).</p> <p>Approximate overall wall thickness represented by a single assembly.</p> <p>Layouts and locations still flexible.</p>	 <p><i>65 B2010-LOD-200 Exterior Walls</i></p>
300	<p>Composite model assembly with specific overall thickness that accounts for veneer, structure, insulation, air space, and interior skin specified for the wall system. (Refer to LOD350 and LOD400 for individually modeled elements)</p> <p>Penetrations are modeled to nominal dimensions for major wall openings such as windows, doors, and large mechanical elements.</p> <p>Required non-graphic information associated with model elements includes:</p> <p style="padding-left: 20px;">Wall type</p> <p>Materials</p>	 <p><i>66 B2010-LOD-300 Exterior Walls</i></p>
350	<p>A composite wall assembly may be considered for LOD350 only if hosted objects such as windows and doors are provided at a minimum of LOD350.</p> <p>Main structural members such as headers and jambs at openings are modeled within the composite assembly.</p>	 <p><i>67 B2010-LOD-350 Exterior Walls</i></p>

Reference Part II Attribute Tables for non-graphical information

B2010 21-02 20 10 Exterior Walls (Masonry)

Includes: Exterior Wall Supplementary Components as appropriate. Includes Exterior Wall Opening Supplementary Components as appropriate. Includes: Solid wall construction that is composite in nature; in other words, multiple layers of materials to form an overall assembly.

Associated Masterformat Sections: 01 83 16

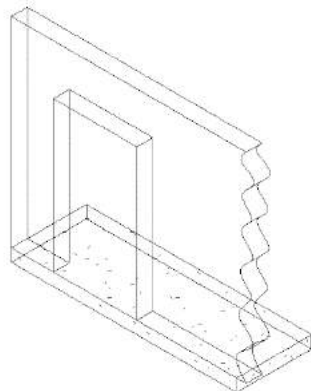
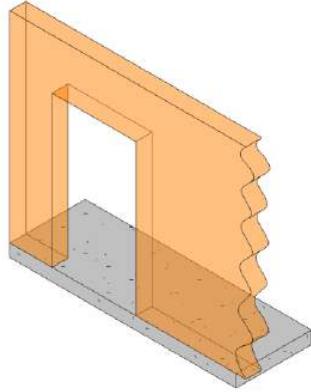
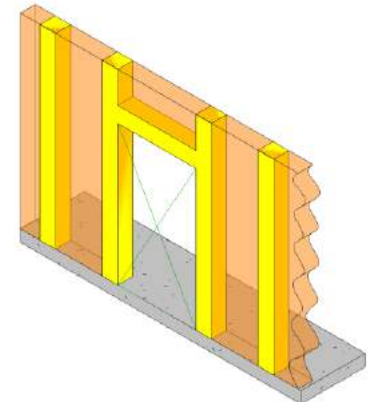
100	See B10	
200	See B2010	 <p>68 B2010.04-LOD-200 Exterior Wall (Masonry)</p>
300	<p>Element modeling to include:</p> <ul style="list-style-type: none"> • Element with design-specified locations and geometries 	 <p>69 B2010.04-LOD-300 Exterior Wall (Masonry)</p>
350	<p>Element modeling to include:</p> <ul style="list-style-type: none"> • Members modeled at any interface with wall edges (top, bottom, sides) or opening through wall • Openings modeled with support framing around openings • Any regions that would impact coordination with other systems such as but not limited to: <ul style="list-style-type: none"> ○ Bond Beam & Lintel Regions ○ Reinforcing & Embed Regions ○ Jam Regions ○ Any other grouted regions 	

Reference Part II Attribute Tables for non-graphical information

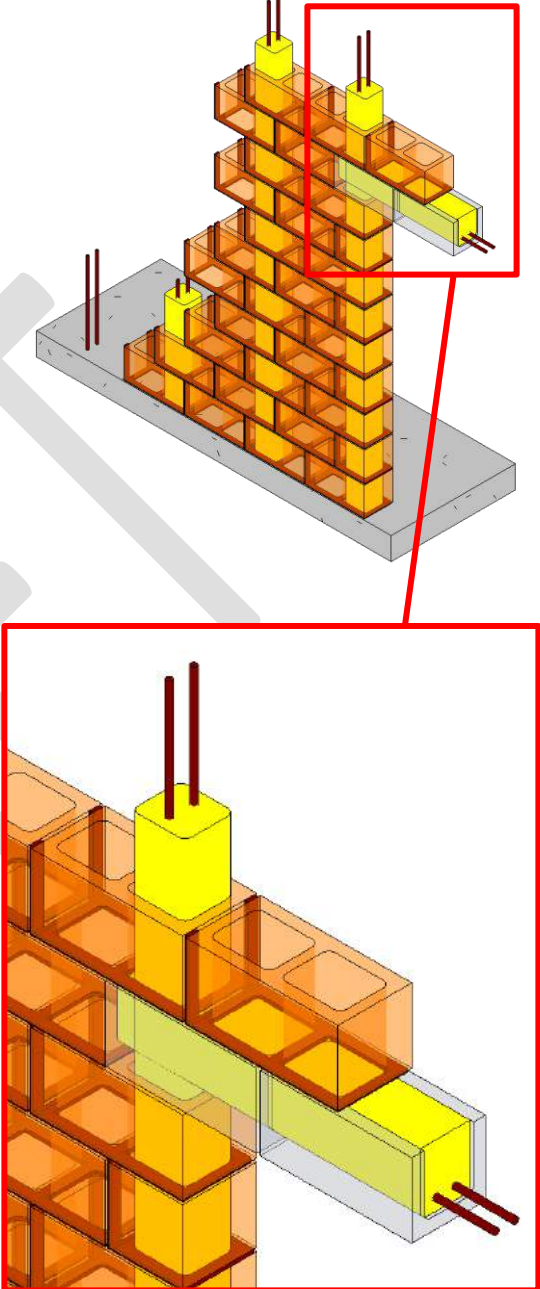
		<i>70 B2010.04-LOD-350 Exterior Wall (Masonry)</i>
400	<p>Element modeling to include:</p> <ul style="list-style-type: none">• Reinforcing• Connections• Grouting Material• Jams• Bond Beams• Lintels• Member fabrication part number• Any part required for complete installation	 <p><i>71 B2010.04-LOD-400 Exterior Wall (Masonry)</i></p>

Reference Part II Attribute Tables for non-graphical information

B2010 21-02 20 10 Exterior Walls (Cold-Form Metal Framing)

Includes: Exterior Wall Supplementary Components as appropriate. Includes Exterior Wall Opening Supplementary Components as appropriate. Includes: Solid wall construction that is composite in nature; in other words, multiple layers of materials to form an overall assembly.

Associated Masterformat Sections: 01 83 16

100	See B20	
200	See B2010	 <p>72 B2010.05-LOD-200 Exterior Wall (Cold-Form Metal Framing)</p>
300	See B2010	 <p>73 B2010.05-LOD-300 Exterior Wall (Cold-Form Metal Framing)</p>

Reference Part II Attribute Tables for non-graphical information

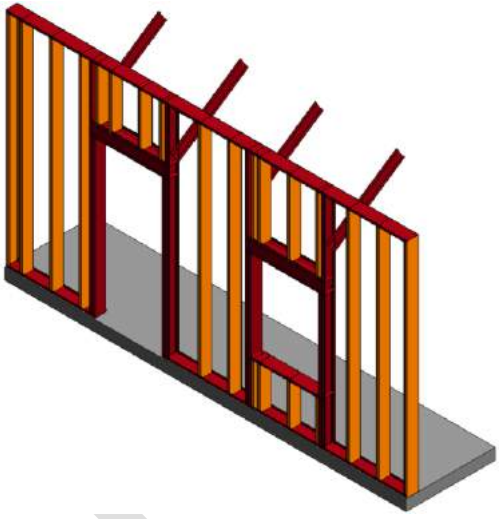
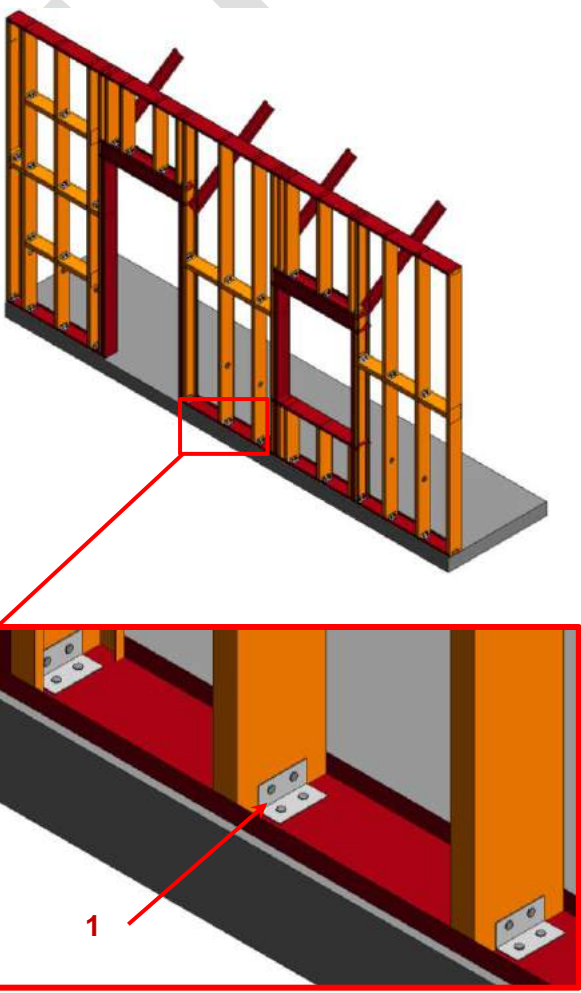
<p>350</p>	<p>Cold formed metal framing is developed with sufficient elements to support detailed interface coordination with other systems such as MEP.</p> <p>Openings modeled with support framing around openings</p> <p><i>Image notes:</i></p> <ol style="list-style-type: none">1) Elements in red are critical wall support elements that cannot be easily cut for coordination of MEP opening through the walls.2) Diagonal bracing (kickers) that may be in the above ceiling space are modeled for coordination with other building content such as MEP passing along the wall in the above ceiling spaces.3) Infill cold formed metal framing modeling (Orange) may be omitted at this LOD if stated in the BXP.4) Cladding and sheathing are not shown for clarity in this image.	 <p>74 B2010.05-LOD-350 Exterior Wall (Cold-Form Metal Framing)</p>
<p>400</p>	<p>Cold formed metal framing is developed with sufficient elements that support the fabrication of the CFMF system.</p> <p><i>Image notes:</i></p> <ol style="list-style-type: none">1) Connection content is development in the wall elements. This includes but is not limited to fasteners, clips, and other related hardware.2) Cladding and sheathing are not shown for clarity in this image.	 <p>75 B2010.05-LOD-400 Exterior Wall (Cold-Form Metal Framing)</p>

Reference Part II Attribute Tables for non-graphical information

B2010 21-02 20 10 Exterior Walls (Wood)

Includes: Exterior Wall Supplementary Components as appropriate. Includes Exterior Wall Opening Supplementary Components as appropriate. Includes: Solid wall construction that is composite in nature; in other words, multiple layers of materials to form an overall assembly.

Associated Masterformat Sections: 01 83 16

100	See B20	
200	See B2010	 <p>76 B2010.06-LOD-200 Exterior Wall (Wood)</p>
300	<p>Composite model assembly with specific overall thickness that accounts for veneer, structure, insulation, air space, and interior skin specified for the wall system. (Refer to LOD350 and LOD400 for individually modeled elements)</p> <p>Penetrations are modeled to nominal dimensions for major wall openings such as windows, doors, and large mechanical elements.</p> <p>Shear panels</p>	 <p>77 B2010.06-LOD-300 Exterior Wall (Wood)</p>

Reference Part II Attribute Tables for non-graphical information

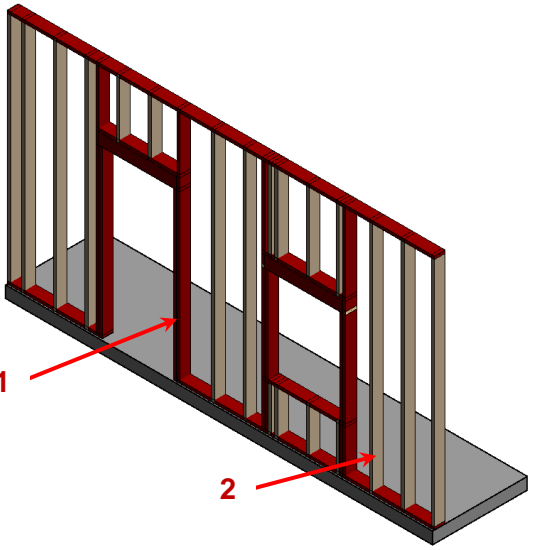
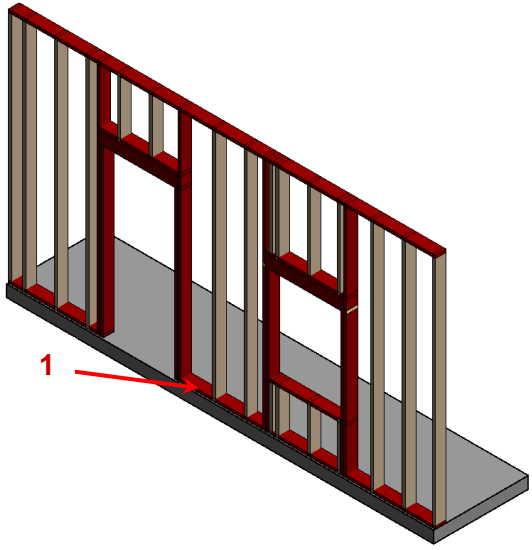
<p>350</p>	<p>Wood framing is developed with sufficient elements to support detailed interface coordination with other systems such as MEP.</p> <p>Openings modeled with support framing around openings</p> <p><i>Image notes:</i></p> <ol style="list-style-type: none">1) <i>Elements in red are critical wall support elements that cannot be easily cut for coordination of MEP opening through the walls.</i>2) <i>Infill wood framing modeling may be omitted at this LOD if stated in the BXP.</i>3) <i>Cladding and sheathing are not shown for clarity in this image.</i>	 <p>78 B2010.06-LOD-350 Exterior Wall (Wood)</p>
<p>400</p>	<p>Wood framing is developed with sufficient elements that support the fabrication of the wood framing system.</p> <p><i>Image notes:</i></p> <ol style="list-style-type: none">1) <i>Connection content is development in the wall elements. This includes but is not limited to fasteners, anchor rods, and other related hardware.</i>2) <i>Cladding and sheathing are not shown for clarity in this image.</i>	 <p>79 B2010.06-LOD-400 Exterior Wall (Wood)</p>

Reference Part II Attribute Tables for non-graphical information

B2010.10 21-02 20 10 10 Exterior Wall Veneer

Includes: Nonstructural outside face elements of exterior walls. Includes precast concrete, unit masonry, EIFS, manufactured siding, and stucco Includes water repellents, coatings, and painting.

*Associated Masterformat Sections: 03 40 00 / 04 20 00 / 04 26 13 / 04 42 00 / 04 43 13
04 70 00 / 05 19 13 / 06 20 13 / 06 61 00 / 07 19 00 / 07 24 00 / 07 42 00 / 07 44 00
07 46 00 / 09 24 00 / 09 24 23 / 09 90 00*

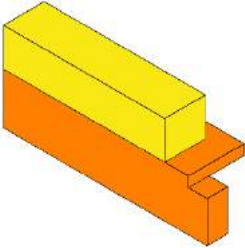
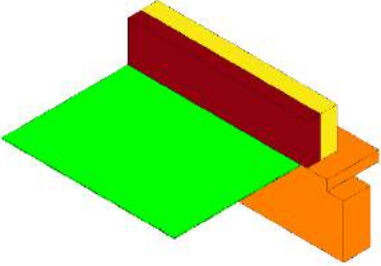
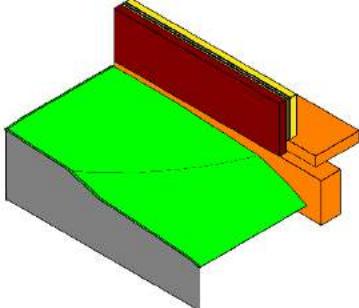
<p>100</p>	<p>See B20</p>	 <p>80 B2010.10-LOD-100 Exterior Wall Veneer</p>
<p>200</p>	<p>See B2010</p>	 <p>81 B2010.10-LOD-200 Exterior Wall Veneer</p>
<p>300</p>	<p>See B2010</p>	 <p>82 B2010.10-LOD-300 Exterior Wall Veneer</p>

Reference Part II Attribute Tables for non-graphical information

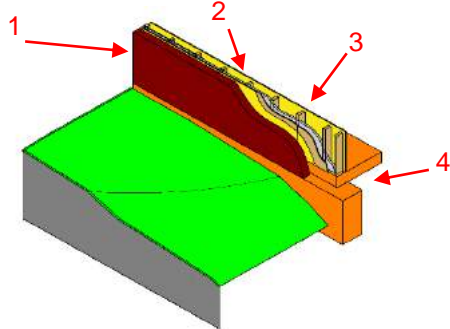
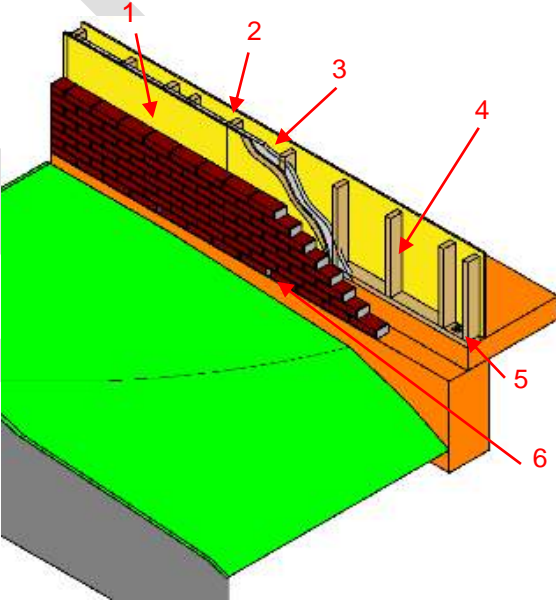
<p>350</p> <p>Exterior wall veneer modeled as a separate element. All openings modeled to rough dimensions. Precast concrete panels are individually modeled. Connection points are specified. Connection to interfacing systems</p> <p><i>Images notes:</i></p> <ol style="list-style-type: none"> 1) Wall veneer element 2) Skin layers including but not limited to waterproofing membrane 3) Core framing 4) Concrete slab edge 		 <p>83 B2010.10-LOD-350 Exterior Wall Veneer</p>
<p>400</p> <p>Element modeling includes:</p> <p><i>Image notes:</i></p> <ol style="list-style-type: none"> 1) Individual masonry units 2) Skin layers including 3) Moisture barrier, sheathing, and insulation 4) Core framing 5) Bolt 6) Concrete slab edge 7) Weep holes 		 <p>84 B2010.10-LOD-400 Exterior Wall Veneer</p>

Reference Part II Attribute Tables for non-graphical information

B2010.20 21-02 20 10 20 Exterior Wall Construction

Includes: Exterior wall construction including backup systems for wall veneer. May be vertical load bearing. Includes cast-in-place concrete walls, precast concrete walls, unit masonry walls, metal framed wall systems, and wood framed wall systems.

*Associated Masterformat Sections: 03 30 00 / 03 40 00 / 04 20 00 / 05 41 00 / 06 11 00
06 12 00 / 06 16 00*

100	See B20	
200	See B2010	
300	See B2010	
350	Exterior wall construction modeled as a separate element. All openings modeled to rough dimensions. Headers and jamb framing are modeled.	
400	Element modeling to include: <ul style="list-style-type: none"> • Studs and tracks • Individual masonry units • Reinforcing • Sheathing • Insulation 	

Reference Part II Attribute Tables for non-graphical information

B2010.20 21-02 20 10 20 Precast Wall (Concrete)

Includes: Exterior wall construction including backup systems for wall veneer. May be vertical load bearing. Includes cast-in-place concrete walls, precast concrete walls, unit masonry walls, metal framed wall systems, and wood framed wall systems.

*Associated Masterformat Sections: 03 30 00 / 03 40 00 / 04 20 00 / 05 41 00 / 06 11 00
06 12 00 / 06 16 00*

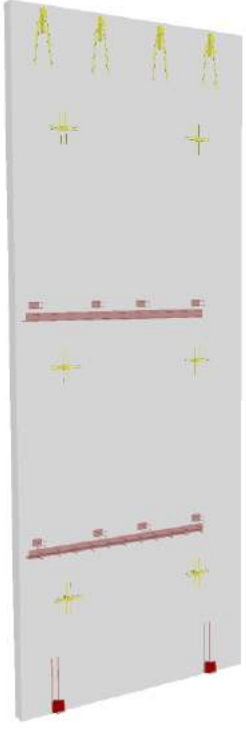
100	See B10	
200	Element modeling to include: <ul style="list-style-type: none"> Type of structural concrete system Approximate geometry (e.g. depth) of structural elements 	
300	Element modeling to include: <ul style="list-style-type: none"> Specific sizes and locations of main concrete structural members modeled per defined structural grid with correct orientation Concrete defined per spec (strength, air entrainment, aggregate size, etc.) All sloping surfaces included in model element with exception of elements affected by manufacturer selection 	
350	Element modeling to include: <ul style="list-style-type: none"> Reinforcing Post-tension profiles and strand locations Reinforcement called out, modeled if required by the BIMXP, typically only in congested areas Pour joints and sequences to help identify reinforcing lap splice locations, scheduling, etc. Expansion Joints Lifting devices Embeds and anchor rods Post-tension profile and strands modeled if required by the BIMXP Penetrations for items such as MEP Any permanent forming or shoring components 	 <p>85 B2010.20– LOD 350 Precast Wall (Concrete)</p>

Reference Part II Attribute Tables for non-graphical information

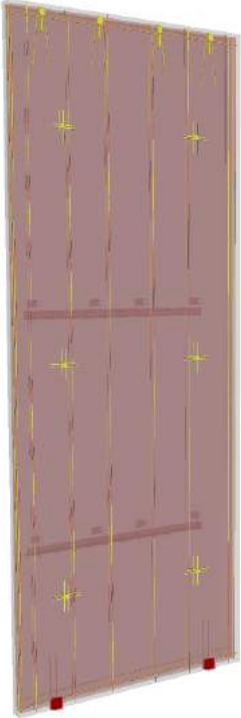
400	<p>Element modeling to include:</p> <ul style="list-style-type: none">• All reinforcement including post tension elements detailed and modeled• Camber, chamfer, reveals, etc.	 <p>86 B2010.20- LOD 400 Precast Wall (Concrete)</p>
-----	---	---

DRAFT

Reference Part II Attribute Tables for non-graphical information

B2010.30 21-02 20 10 30 Exterior Wall Interior Skin

Includes: Materials to provide finish or protective covering on inside of face of exterior walls. May include insulation and vapor retarder.

Associated Masterformat Sections: 09 20 00

100	See B20	
200	See B2010	
300	See B2010	
350	Exterior wall interior skin modeled as a separate element. All openings modeled to rough dimensions.	
400	Element modeling to include: <ul style="list-style-type: none"> • Studs and tracks • Individual masonry units • Reinforcing • Wall board • Insulation 	

B2010.50 21-02 20 10 50 Parapets

Includes: Exterior wall construction above plane of roof.

*Associated Masterformat Sections: 03 30 00 / 03 40 00 / 04 20 00 / 05 41 00 / 06 11 00
06 12 00 / 06 16 00*

[See [B2010](#), [B2010.10](#), [B2010.20](#), and [B2010.30](#)]

B2010.60 21-02 20 10 60 Equipment Screens

Includes: Exterior wall construction to screen equipment from public view.

Associated Masterformat Sections: 03 40 00 / 04 20 00 / 08 92 00

[See [B2010](#), [B2010.10](#), [B2010.20](#), and [B2010.30](#)]

B2020 21-02 20 20 Exterior Windows

Includes: Fixed or operable windows used singly and in multiples located in the exterior vertical enclosure. Includes Exterior Window Supplementary Components as appropriate. Includes windows units with louver blinds integrally set between glass panels. Includes metal, wood, plastic, and composite window units. May Include: Wall Opening Supplementary Components as appropriate.

Associated Masterformat Sections: 01 83 16 / 08 50 00

100	See B20	
200	Windows approximate in terms of location, size, count and type. Units are modeled as a simple, monolithic component; or represented with simple frame and glazing. Nominal unit size is provided.	

Reference Part II Attribute Tables for non-graphical information

B2020.10 21-02 20 20 10 Exterior Operating Windows

Includes: Window screens and storm windows.

Associated Masterformat Sections: 08 50 00 / 08 51 66 / 08 52 66 / 08 53 66 / 08 54 66
08 51 69 / 08 52 69 / 08 53 69 / 08 54 69

100	See B20	
200	See B2020	
300	Units are modeled based on specified location and nominal size. Outer geometry (profile) of window frame elements and glazing modeled in correct location Operation is indicated.	
350	Rough opening dimensions Attachment method of window to structure Embed elements Backer rod and sealant	
400	Detailed frame extrusion profiles Glazing sub-components (gaskets) Attachment components <ul style="list-style-type: none"> • End dam • Fasteners 	

B2020.20 21-02 20 20 20 Exterior Fixed Windows

Associated Masterformat Sections: 08 50 00

[See [B2020.10](#)]

Reference Part II Attribute Tables for non-graphical information

B2020.30

21-02 20 20 30

Exterior Window Wall

Associated Masterformat Sections: 08 43 00

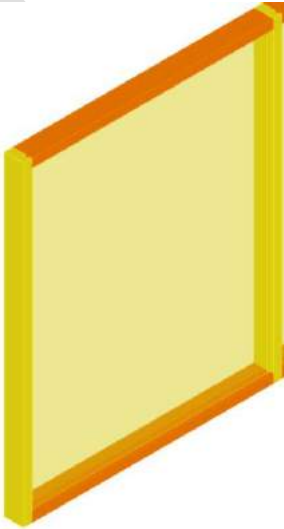
100	See B20	
200	<p>Generic wall objects representing major types of proposed window wall assemblies.</p> <p>Overall window wall assembly depth represented by a single model object.</p> <p>Layouts and locations still flexible.</p>	 <p><i>87 B2020.30-LOD-200 Exterior Window Wall</i></p>
300	<p>Specified location and orientation of face of glass.</p> <p>Nominal face dimensions and thickness of glazing.</p> <p>Structural support systems of wall to be modeled.</p> <p>Spacing, location, size and orientation of mullions.</p> <p>Operable components defined (windows, louvers and doors) and included in model.</p>	 <p><i>88 B2020.30-LOD-300 Exterior Window Wall</i></p>

Reference Part II Attribute Tables for non-graphical information

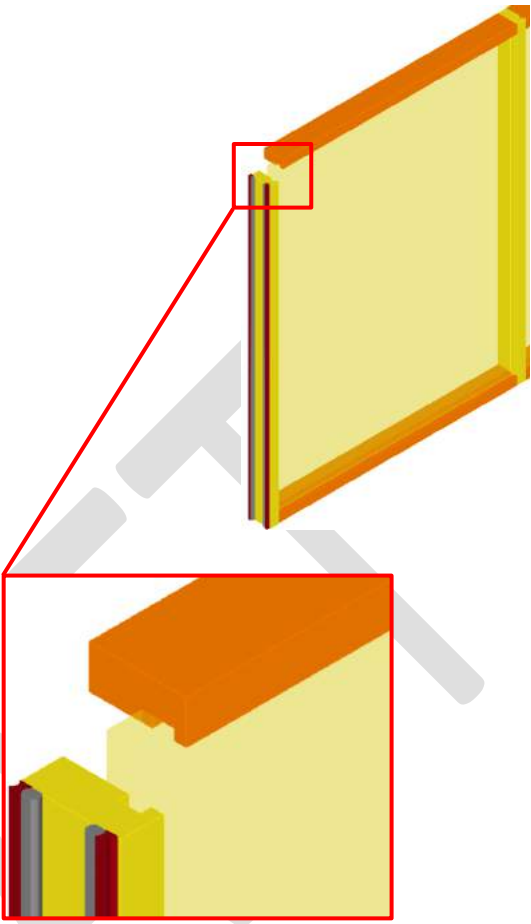
350	Mullion shapes and geometry defined. Actual anchorage layouts and types modeled. Actual panel dimensions (including seating).	 <p data-bbox="764 1178 1242 1207"><i>89 B2020.30-LOD-350 Exterior Window Wall</i></p>
-----	---	---

Reference Part II Attribute Tables for non-graphical information

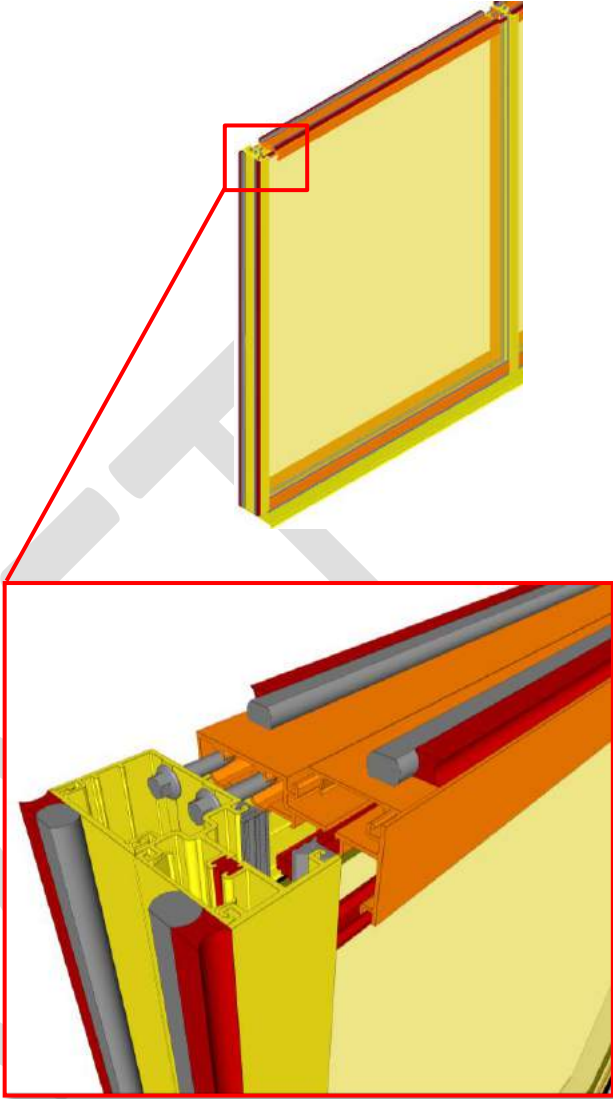
<p>400</p>	<p>Complete mullion extrusion profiles. Interface details between wall systems (within) and wall and support systems including sealants, end dams, flashings and membranes.</p>	 <p>90 B2020.30-LOD-400 Exterior Window Wall</p>
------------	---	---

B2020.50

21-02 20 20 50

Exterior Special Function Windows

Includes: Exterior windows with special characteristics for a special function.

Associated Masterformat Sections: 08 56 00 / 08 55 00 / 08 88 39 / 08 56 19 / 08 56 46
08 56 49 / 08 88 49 / 08 56 53 / 08 88 53 / 08 88 56 / 08 56 63 / 08 56 73 / 08 75 00
08 80 00

[See [B2020.10](#)]

Reference Part II Attribute Tables for non-graphical information**B2050 21-02 20 50 Exterior Doors and Grilles**

Includes: Doors, grilles, and gates located in the exterior vertical enclosure. Includes screen and storm door assemblies. Includes Exterior Door Supplementary Components as appropriate. May Include: Wall Opening Supplementary Components as appropriate.

Associated Masterformat Sections: 01 83 16

100	Simple representation of a door unit. Size, count, and location are approximate.	
200	Units are modeled as a simple, monolithic component; or represented with simple frame and panel. Nominal unit size is provided.	

B2050.10 21-02 20 50 10 Exterior Entrance Doors

Includes: Exterior personnel door assemblies at main entrances. Includes automatic, revolving, balanced, and other special operating entrance doors, and sliding storefront wall systems.

Associated Masterformat Sections: 08 32 00 / 08 42 00 / 08 42 26 / 08 42 29 / 08 42 33
08 42 36 / 08 43 29

100	See B20	
200	See B2050	
300	Entrance door assemblies modeled by type to include the following: Specific door panels and frames (if applicable). Operation is specified. Spatial requirements for operation may be modeled if required by BIMXP.	
350	Rough opening is modeled (if applicable). Major framing elements are modeled at jambs and head. Thresholds Operation or mechanism enclosures are modeled. All connections and interfaces modeled including brackets and supports.	
400	Complete mullion extrusion profiles Actual panel size dimensions. .	

Reference Part II Attribute Tables for non-graphical information

B2050.20 21-02 20 50 20 Exterior Utility Doors

Includes: Exterior personnel door assemblies other than at main entrances.

Associated Masterformat Sections: 08 10 00

100	See B20	
200	See B2050	
300	See B2050.10	
350	See B2050.10	
400	All connections and interfaces modeled including brackets, supports, sealants, and thresholds.	

B2050.30 21-02 20 50 30 Exterior Oversize Doors

Includes: Large exterior door assemblies to allow for passage of large objects involving various operating methods. Includes Exterior Door Supplementary Components as appropriate including operators and drive mechanisms.

*Associated Masterformat Sections: 08 33 00 / 08 36 00 / 08 36 13 / 08 36 16 / 08 36 19
08 36 23 / 08 34 16*

100	See B20	
200	See B2050	
300	Oversize door assemblies modeled by type to include the following: Door panels with nominal dimensions. Frames with nominal dimensions. Clearance zones are modeled for operation of overhead doors (other than coiling doors). Enclosures and motor housings are modeled with overall nominal dimensions.	
350	Rough opening is modeled (if applicable). Major framing elements in wall are modeled at jambs and head. Attachment elements are modeled	
400	All connections and interfaces modeled including brackets, supports, sealants, and thresholds.	

B2050.40 21-02 20 50 40 Exterior Special Function Doors

Includes: Exterior door assemblies for a variety of special functions and applications involving a variety of operating methods. Includes Exterior Door Supplementary Components as appropriate including controls and operators.

*Associated Masterformat Sections: 08 30 00 / 08 34 13 / 08 34 19 / 08 34 46 / 08 34 49
08 34 53 / 08 34 63 / 08 34 73 / 08 38 00 / 08 39 00 / 08 88 49 / 08 88 53 / 08 88 56*

[See [B2050.20](#) or [B2050.30](#)]

B2050.60 21-02 20 50 60 Exterior Grilles

Includes: Exterior devices of open construction to provide moveable barrier to provide access through wall or other divider.

Associated Masterformat Sections: 08 33 00 / 08 35 16

100	See B20	
-----	-------------------------	--

Reference Part II Attribute Tables for non-graphical information

200	See B2050	
300	Grille assemblies modeled by type to include the following: Nominal size of unit. Operation is specified.	
350	Rough opening is modeled (if applicable). Major framing elements are modeled at jambs and head.	
400	All connections and interfaces modeled including brackets, supports, sealants, and thresholds.	

B2050.70 21-02 20 50 70 Exterior Gates

Includes: Exterior devices of solid or open construction to provide moveable barrier to provide access through wall or other divider.

Associated Masterformat Sections: 08 34 56

[See [B2050.60](#)]

B2050.90 21-02 20 70 Exterior Door Supplementary Components

Includes frames, hardware, glazing and louvers that are part of door to be included with exterior door elements above as appropriate.

These components are typically modeled as part of other assemblies listed in the tables above. Do not assign this Uniformat classification unless a supplementary component is modeled independently of another assembly.

Associated Masterformat Sections: 08 10 00 / 08 30 00 / 08 71 00 / 08 80 00 / 08 91 26

B2070 Exterior Louvers and Vents

Includes: Exterior louvers which are not an integral part of mechanical equipment, including louvers connected to ducts.

Associated Masterformat Sections: 08 90 00

100	See B20	
200	Generic model element that is indicative of approximate area and location of intended louver/vent.	

Reference Part II Attribute Tables for non-graphical information**B2070.10 21-02 20 70 10 Exterior Louvers**

Associated Masterformat Sections: 01 83 16 / 08 91 00

100	See B20	
200	See B2070	
300	Louver assembly modeled by type, indicative of area and location of intended louver/vent. Accurate frame and blade boundary areas. Opening for louver is cut from host wall	
350	Rough opening is modeled (if applicable) Major framing elements are modeled at connection points. Connection points are modeled.	
400	All connections and interfaces modeled including brackets, supports, and sealants.	

B2070.50 21-02 20 70 50 Exterior Vents

Associated Masterformat Sections: 08 95 00

[See [B2070.10](#)]**B2080 21-02 20 80 Exterior Wall Appurtenances***Includes: Exterior enclosures, grilles and screens of wood, metal, plastic, and other materials for a variety of purposes including screening of equipment.*

Associated Masterformat Sections:

[See [B2050](#)]**B2080.10 21-02 20 80 10 Exterior Fixed Grilles and Screens***Includes: Exterior enclosures, grilles and screens of wood, metal, plastic, and other materials for a variety of purposes including screening of equipment.*

Associated Masterformat Sections: 05 70 00 / 06 49 00 / 06 60 00 / 06 80 00 / 10 82 13

[See [B2050.60](#)]**B2080.30 21-02 20 80 30 Exterior Opening Protection Devices***Includes: Manufactured items such as louvers, fins, shutters, demountable panels, awnings, and sun screens to provide sun control, privacy, security, insulation, and storm protection on exterior of windows, skylights, and entrances. Includes fixed and moveable, manually and electrically operated, and automatically controlled devices.*

Associated Masterformat Sections: 10 71 00 / 10 71 13 / 10 71 16 / 10 73 13

[See [B2010.60](#)]

Reference Part II Attribute Tables for non-graphical information**B2080.50 21-02 20 80 50 Exterior Balcony Walls and Railings**

Includes: Exterior enclosures, grilles and screens of wood, metal, plastic, and other materials for a variety of purposes including screening of equipment.

Associated Masterformat Sections: 03 30 00 / 03 40 00 / 04 20 00 / 05 41 00 / 06 11 00
06 16 00 / 05 52 00 / 05 73 00 / 06 43 16 / 06 63 00 / 06 81 00

[See [B2010.50](#)]

B2080.70 21-02 20 80 70 Exterior Fabrications

Includes: Exterior fabrications of a variety of materials formed to various profiles for a variety of purposes including column covers, decorative metal, ornamental woodwork, and plaster fabrications.

Associated Masterformat Sections: 03 49 00 / 05 50 00 / 05 58 13 / 05 70 00 / 06 44 00
06 60 00 / 06 61 00 / 06 80 00 / 09 27 00

[See [Fundamental LOD Definitions](#)]

B2080.80 21-02 20 80 80 Bird Control Devices

Includes: Mechanical, electrical, physical, and chemical repellent systems, and protective devices.

Associated Masterformat Sections: 10 81 13

[See [Fundamental LOD Definitions](#)]

B2090 21-02 20 90 Exterior Wall Specialties

Includes: Complete fabrication of metal, wood, and fiberglass, including accessories and appurtenances. For example, clocks, below-grade egress assemblies, and window wells.

Associated Masterformat Sections: 07 77 00 / 10 74 00 / 10 74 13 / 10 74 43 / 10 74 46

[See [Fundamental LOD Definitions](#)]

B30 21-02 30 Exterior Horizontal Enclosures

Associated Masterformat Sections: 01 83 16

100	Solid mass model representing overall building volume; or, schematic wall elements that are not distinguishable by type or material. Assembly depth/thickness and locations still flexible.	
-----	--	--

B3010 21-02 30 10 Roofing

Associated Masterformat Sections: 01 83 19

100	See B30	
200	Generic assembly that contains spatial (layer) allowance for structural slab/deck and/or framing system.	
300	Individual substrate layers are not separately modeled, but they are specified within a composite assembly. Roof structure is modeled separately.	

Reference Part II Attribute Tables for non-graphical information

B3010.10 21-02 30 10 10 Steep Slope Roofing

Includes: Lapped roofing shingles, shakes and roofing tiles, including fastening and flashing products and methods. Includes Roofing Supplementary Components as appropriate.

Steep slope roofing material is often modeled as a layer within the overall roof structure assembly.

Associated Masterformat Sections: 01 83 19 / 07 30 00 / 07 31 00 / 07 32 00 / 07 41 00
07 61 00 / 07 63 00

[See [B1020](#)]

B3010.50 21-02 30 10 50 Low-Slope Roofing

Includes: Membrane roofing of various types and protected membrane roofing, including fastening and flashing products. Includes Roofing Supplementary Components as appropriate.

Associated Masterformat Sections: 01 83 19 / 07 50 00 / 07 55 00 / 07 55 63 / 07 76 00

100	See B30	
200	See B3010	
300	Specific material thickness, openings are subtracted from solid. Framing is a separate assembly, see B10 . Drainage pitches are modeled.	

B3010.70 21-02 30 10 70 Canopy Roofing

Includes: Roofing of various types over canopies. Includes Roofing Supplementary Components as appropriate.

Associated Masterformat Sections:

[See [B3010.10](#) or [B3010.50](#)]

B3010.90 21-02 30 10 90 Roofing Supplementary Components

Includes: substrate boards, vapor retarder, air barriers, deck insulation, flashing and sheet metal, and expansion joints to be included with roofing elements above as appropriate.

These components are typically modeled as part of other assemblies listed in the tables above. Do not assign this Uniformat classification unless a supplementary component is modeled independently of another assembly.

Associated Masterformat Sections: 07 22 00 / 07 26 00 / 07 27 00 / 07 62 00 / 07 65 00
07 71 13 / 07 71 16 / 07 71 19 / 07 71 29 / 09 28 00

B3020 21-02 30 20 Roof Appurtenances

Includes: Roof specialties and accessories installed on or in roofing or traffic bearing horizontal enclosure systems. Includes components for the management of rainwater, but excludes mechanical and structural items.

Associated Masterformat Sections:

100	See B30	
200	See Fundamental LOD Definitions	

Reference Part II Attribute Tables for non-graphical information**B3020.10 21-02 30 20 10 Roof Accessories***Includes: Ladders, curbs, vents, walkways, and snow guards.*Associated Masterformat Sections: 05 51 33 / 07 72 00 / 07 72 13 / 07 72 23 / 07 72 26
07 72 46 / 07 72 53

100	See B30	
200	See Fundamental LOD Definitions	
300	<u>Ladders</u> : Specific assemblies indicating length and width. <u>Walkways</u> : Specific assemblies indicating length, width, and rail/guard height. <u>Vents</u> : Specific assemblies indicating roof opening size. Roof opening element is included.	
350	<u>Ladders</u> : Specific assemblies indicating length, width, and attachment/anchoring members. Required access/clearance space is modeled. <u>Walkways</u> : Specific assemblies indicating length, width, rail/guard height, and support/attachment/anchoring members. Required access/clearance space is modeled. <u>Vents</u> : Specific assemblies indicating roof opening size and attachment/anchoring members if applicable. Required service access space is modeled.	
400	See Fundamental LOD Definitions	

B3020.30 21-02 30 20 30 Roof Specialties*Includes: Cupolas, spires, steeples, and weathervanes.*

Associated Masterformat Sections: 10 74 00 / 10 74 23 / 10 74 26 / 10 74 29 / 10 74 33

[See [Fundamental LOD Definitions](#)]**B3020.70 21-02 30 20 70 Rainwater Management***Includes: Components to manage rain water from roofing and traffic bearing horizontal enclosures. Includes: Conductor heads, gutters, downspouts, scuppers, and splash blocks.*

Associated Masterformat Sections: 07 71 23 / 07 71 33 / 03 48 16

[See [D2030.10](#) and [D2030.20](#)]**B3040 21-02 30 40 Traffic Bearing Horizontal Enclosures***Includes: Horizontal enclosures that are also traffic bearing. Includes Horizontal Enclosure Supplementary Components as appropriate.*

Associated Masterformat Sections: 01 83 16

100	See B30	
200	Modeled as part of other composite assembly. See B3010 .	

B3040.10 21-02 30 40 10 Traffic Bearing Coatings*Includes: Surface applied waterproofing exposed to weather and suitable for pedestrian or vehicular traffic.*

Associated Masterformat Sections: 07 18 00

Reference Part II Attribute Tables for non-graphical information

B3040.30 21-02 30 40 30 Horizontal Waterproofing Membrane

Includes: Substrate board, deck insulation, vapor retarder, sheet metal flashing and trim, flexible flashing, and expansion joints.

Associated Masterformat Sections: 07 10 00

100	See B30	
200	See B3040	
300	Membrane assembly modeled by type to specified thickness. Major openings such as shafts and hatches are modeled.	
350	Individual material layers of membrane assembly are modeled separately. All openings and penetrations are modeled. Expansion joints are modeled indicating specific width.	

B3040.50 21-02 30 40 50 Wear Surfaces

Includes: Wearing surfaces on top of horizontal waterproofing membrane that are suitable for pedestrian or vehicular traffic.

Associated Masterformat Sections: 07 76 00 / 32 13 00 / 32 14 00

100	See B30	
200	See B3040	
300	Wear surface system modeled by type to specified thickness/depth. Major openings such as shafts and hatches are modeled.	
350	Individual system elements are modeled separately. Pedestals are modeled and located properly, if applicable. Expansion joints are modeled indicating specific width.	

B3040.90 21-02 30 40 90 Horizontal Enclosure Supplementary Components

Includes: Substrate board, deck insulation, vapor retarder, sheet metal flashing and trim, flexible flashing, and expansion joints to be included with horizontal enclosure elements above as appropriate.

These components are typically modeled as part of other assemblies listed in the tables above. Do not assign this Uniformat classification unless a supplementary component is modeled independently of another assembly.

Associated Masterformat Sections: 07 20 00 / 07 26 00 / 07 62 00 / 07 65 00 / 07 71 13
07 71 16 / 07 71 19 / 07 71 29 / 09 28 00

B3060 21-02 30 60 Horizontal Openings

Includes: Openings in horizontal enclosures including roofing and traffic bearing horizontal enclosures. Includes Horizontal Opening Supplementary Components as appropriate.

Associated Masterformat Sections:

100	See B30	
200	See B2020	

Reference Part II Attribute Tables for non-graphical information

B3060.10 21-02 30 60 10 Roof Windows and Skylights

Includes: Operable and non-operable roof windows. Includes: Skylights without framing with plastic and glass glazing. Includes: Skylights with framing.

Associated Masterformat Sections: 01 83 16 / 08 60 00 / 08 61 00 / 08 62 00 / 08 63 00
08 64 00 / 08 67 00

[See [B2020.10](#)]

B3060.50 21-02 30 60 50 Vents and Hatches

Includes: Other roof openings such as roof hatches, smoke vents, and gravity roof ventilators.

Associated Masterformat Sections: 07 72 33 / 07 72 36

[See [B3020.10](#)]

B3060.90 21-02 30 60 90 Horizontal Opening Supplementary Components

Includes: Frames, hardware, glazing, flashing, and joint sealants to be included with horizontal opening elements above as appropriate.

These components are typically modeled as part of other assemblies listed in the tables above. Do not assign this Uniformat classification unless a supplementary component is modeled independently of another assembly.

Associated Masterformat Sections: 08 75 00 / 08 80 00 / 07 60 00 / 07 92 00

B3080 21-02 30 80 Overhead Exterior Enclosures

Includes: Exposed to weather construction under horizontal enclosure construction. Includes suspension and support systems, insulation, vapor retarders, and air barriers.

Associated Masterformat Sections: 01 83 16

100	See B30	
200	Generic assemblies indicative of overall scope and approximate thickness/system depth of overhead enclosure.	

B3080.10 21-02 30 80 10 Exterior Ceilings

Associated Masterformat Sections: 07 42 00 / 07 44 00 / 09 20 00 / 09 54 00 / 09 56 00
09 90 00

100	See B30	
200	See B3080	
300	Overall assembly modeled to specific system thickness including structural backing. Location of expansion or control joints indicated, but not modeled.	
350	Face material modeled to specific thickness. Structural backing members including bracing/lateral framing/kickers are modeled. Expansion or control joints are modeled to indicate specific width.	

Reference Part II Attribute Tables for non-graphical information

400	<p>Individual elements of face material are modeled.</p> <p>Structural backing members and all support members (kickers) are modeled including all connections.</p> <p>Expansion or control joints are modeled.</p>	
-----	---	--

B3080.20 21-02 30 80 20 Exterior Soffits

Associated Masterformat Sections: 07 42 93 / 07 44 00 / 08 95 13 / 09 20 00 / 09 54 00
09 56 00 / 09 90 00

[See [B3080.10](#)]

B3080.30 21-02 30 80 30 Exterior Bulkheads

Associated Masterformat Sections: 07 42 00 / 07 44 00 / 09 20 00 / 09 54 00 / 09 56 00
09 90 00

[See [B3080.10](#)]

DRAFT

Reference Part II Attribute Tables for non-graphical information**C 21-03 INTERIORS**

Associated Masterformat Sections: 01 84 00

C10 21-03 10 Interior Construction

Associated Masterformat Sections: 01 84 13

100	A schematic model element or symbol that is not distinguishable by type or material. Types, layouts, and locations are still flexible.	
-----	---	--

C1010 21-03 10 10 Interior Partitions

Includes: Enclosures and partitions which are fixed and secured in place. Includes walls of concrete; and masonry; and wood and metal stud partitions with associated wall surfaces. Includes partitions of an open nature, such as wire mesh partitions. Partitions may be load bearing or non-load bearing. Includes Interior Partition Supplementary Components as appropriate.

Associated Masterformat Sections: 10 22 00 / 01 84 13

100	See C10	
200	Generic wall objects separated by type of material (e.g. gypsum board vs. masonry). Approximate overall wall thickness represented by a single assembly. Layouts, locations, heights, and elevation profiles are still flexible.	

Reference Part II Attribute Tables for non-graphical information

C1010.10 21-03 10 10 10 Interior Fixed Partitions

Includes: Enclosures and partitions which are fixed and secured in place. Includes walls of concrete; and masonry; and wood and metal stud partitions with associated wall surfaces. Includes partitions of an open nature, such as wire mesh partitions. Partitions may be load bearing or non-load bearing. Includes Interior Partition Supplementary Components as appropriate.

Associated Masterformat Sections: 03 30 00 / 03 40 00 / 04 20 00 / 05 41 00 / 06 11 00 / 09 20 00 / 10 22 13

100	See C10	
200	See C1010	
300	<p>Composite model assembly by type with overall thickness that accounts for framing and finish specified for the wall system. (Refer to LOD350 and LOD400 for individually modeled elements)</p> <p>Wall elements are modeled to specific layouts, locations, heights, and elevation profiles. Penetrations are modeled to nominal dimensions for major wall openings such as windows, doors, and large mechanical elements.</p>	
350	<p>Structure and finish layers of partition assembly modeled as separate elements.</p> <p>All openings modeled to rough dimensions.</p> <p>Major framing elements such as king studs, kickers, diagonal bracing, and headers are modeled.</p>	
400	<p>Element modeling to include:</p> <ul style="list-style-type: none"> • Studs and tracks • Bracing • Insulation • Sheathing or wall boards • Openings/penetrations 	

Reference Part II Attribute Tables for non-graphical information

C1010.10.10 21-03 10 10 10 10 Interior Wall (Masonry)

Includes: Enclosures and partitions which are fixed and secured in place. Includes walls of concrete; and masonry; and wood and metal stud partitions with associated wall surfaces. Includes partitions of an open nature, such as wire mesh partitions. Partitions may be load bearing or non-load bearing. Includes Interior Partition Supplementary Components as appropriate.

Associated Masterformat Sections: 10 22 00 / 01 84 13

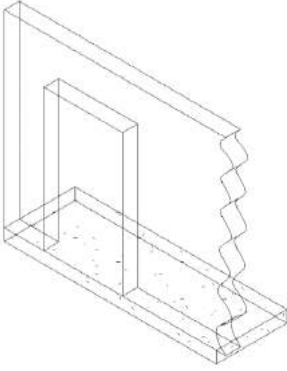
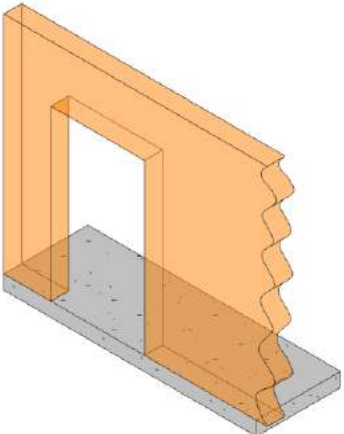
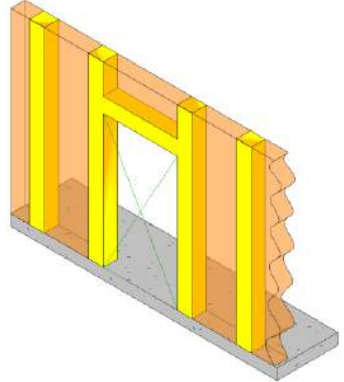
100	See C10	
200	See C1010	 <p>91 C1010.04-LOD-200 Interior Wall (Masonry)</p>
300	See C1010.10	 <p>92 C1010.04-LOD-300 Interior Wall (Masonry)</p>
350	<p>Element modeling to include:</p> <ul style="list-style-type: none"> • Members modeled at any interface with wall edges (top, bottom, sides) or opening through wall • Any regions that would impact coordination with other systems such as but not limited to: <ul style="list-style-type: none"> ○ Bond Beam & Lintel Regions ○ Reinforcing & Embed Regions ○ Jam Regions 	 <p>93 C1010.04-LOD-350 Interior Wall (Masonry)</p>

Reference Part II Attribute Tables for non-graphical information

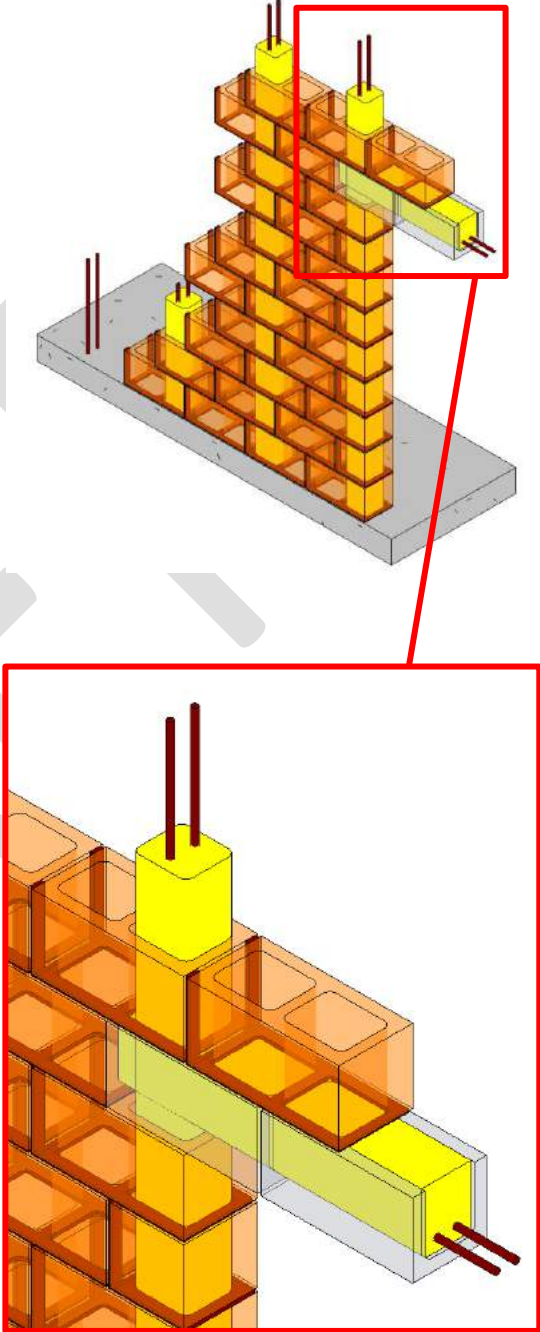
400	<p>Element modeling to include:</p> <ul style="list-style-type: none">• Reinforcing• Connections• Grouting Material• Jams• Bond Beams• Lintels• Member fabrication part number• Any part required for complete installation	 <p>94 C1010.04-LOD-400 Interior Wall (Masonry)</p>
-----	--	--

Reference Part II Attribute Tables for non-graphical information

C1010.10.20 21-03 10 10 10 20 Interior Wall (Cold-Form Metal Framing)

Includes: Enclosures and partitions which are fixed and secured in place. Includes walls of concrete; and masonry; and wood and metal stud partitions with associated wall surfaces. Includes partitions of an open nature, such as wire mesh partitions. Partitions may be load bearing or non-load bearing. Includes Interior Partition Supplementary Components as appropriate.

Associated Masterformat Sections: 10 22 00 / 01 84 13

100	See C10	
200	See C1010	 <p>95 C1010.05-LOD-200 Interior Wall (Cold-Form Metal Framing)</p>
300	See C1010.10	 <p>96 C1010.05-LOD-300 Interior Wall (Cold-Form Metal Framing)</p>

Reference Part II Attribute Tables for non-graphical information

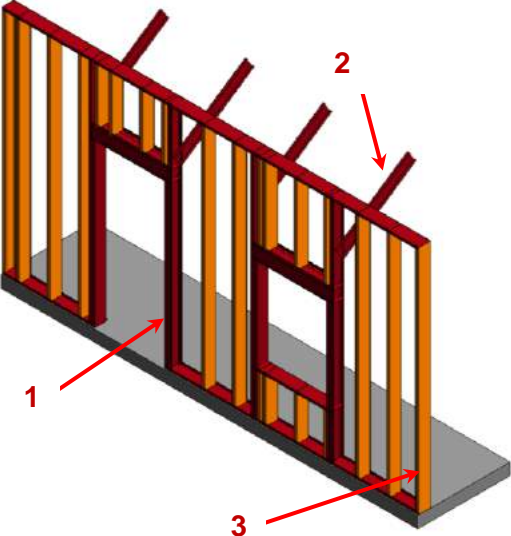
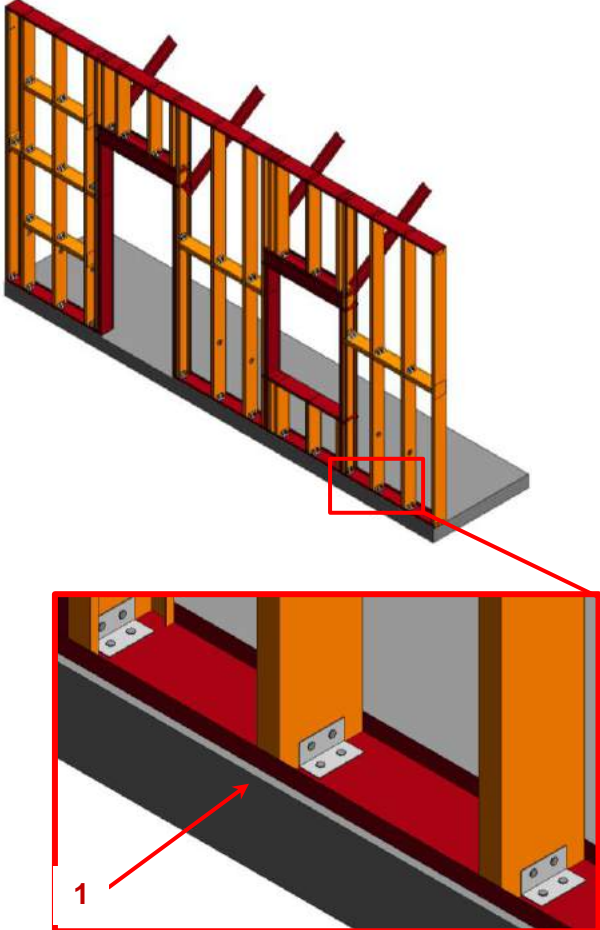
<p>350</p> <p>Cold formed metal framing is developed with sufficient elements to support detailed interface coordination with other systems such as MEP.</p> <p><i>Image notes:</i></p> <ol style="list-style-type: none">1) Elements in red are critical wall support elements that cannot be easily cut for coordination of MEP opening through the walls.2) Diagonal bracing (kickers) that may be in the above ceiling space are modeled for coordination with other building content such as MEP passing along the wall in the above ceiling spaces.3) Infill CFMF modeling (Orange) may be omitted at this LOD if stated in the BXP.4) Cladding and sheathing are not shown for clarity in this image.		 <p>97 C1010.05-LOD-350 Interior Wall (Cold-Form Metal Framing)</p>
<p>400</p> <p>Cold formed metal framing is developed with sufficient elements that support the fabrication of the CFMF system.</p> <p><i>Image notes:</i></p> <ol style="list-style-type: none">1) Connection content is development in the wall elements. This includes but is not limited to fasteners, clips, and other related hardware.2) Cladding and sheathing are not shown for clarity in this image.		 <p>98 C1010.05-LOD-400 Interior Wall (Cold-Form Metal Framing)</p>

Reference Part II Attribute Tables for non-graphical information

C1010.10.30 21-03 10 10 10 30 Interior Wall (Wood)

Includes: Enclosures and partitions which are fixed and secured in place. Includes walls of concrete; and masonry; and wood and metal stud partitions with associated wall surfaces. Includes partitions of an open nature, such as wire mesh partitions. Partitions may be load bearing or non-load bearing. Includes Interior Partition Supplementary Components as appropriate.

Associated Masterformat Sections: 10 22 00 / 01 84 13

100	See C10	
200	See C1010	 <p>99 C1010.06-LOD-200 Interior Wall (Wood)</p>
300	See C1010	 <p>100 C1010.06-LOD-300 Interior Wall (Wood)</p>

Reference Part II Attribute Tables for non-graphical information

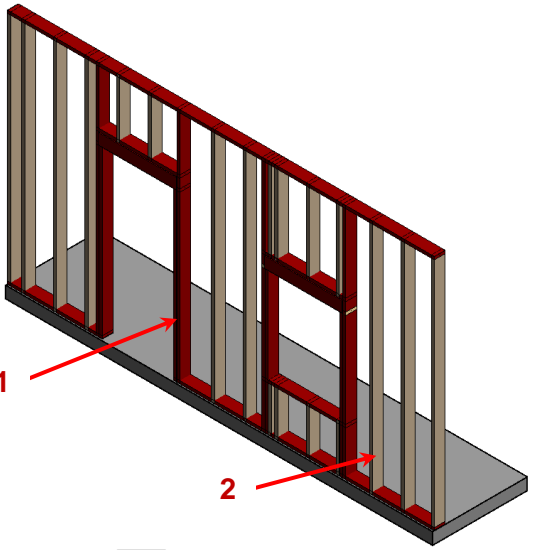
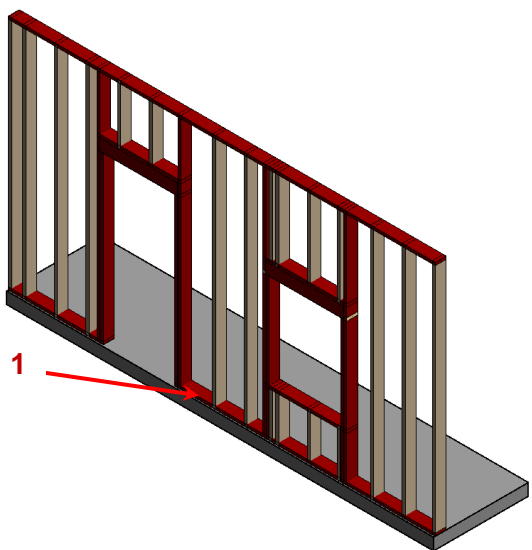
<p>350</p>	<p>Wood framing is developed with sufficient elements to support detailed interface coordination with other systems such as MEP.</p> <p><i>Image notes:</i></p> <ol style="list-style-type: none">1) Elements in red are critical wall support elements that cannot be easily cut for coordination of MEP opening through the walls.2) Infill wood framing modeling may be omitted at this LOD if stated in the BXP.3) Cladding and sheathing are not shown for clarity in this image.	 <p>101 C1010.06-LOD-350 Interior Wall (Wood)</p>
<p>400</p>	<p>Wood framing is developed with sufficient elements that support the fabrication of the wood framing system.</p> <p>Openings and penetrations through studs are modeled.</p> <p><i>Image notes:</i></p> <ol style="list-style-type: none">1) Connection content is development in the wall elements. This includes but is not limited to fasteners, anchor rods, and other related hardware.2) Cladding and sheathing are not shown for clarity in this image.	 <p>102 C1010.06-LOD-400 Interior Wall (Wood)</p>

Reference Part II Attribute Tables for non-graphical information

C1010.20 21-03 10 10 20 Interior Glazed Partitions

Includes: Partitions primarily composed of glazed elements that may be fabricated or field constructed. Includes Interior Partition Supplementary Components as appropriate.

Associated Masterformat Sections: 08 43 00

100	See C10	
200	See C1010	
300	Specified location and orientation of face of glass. Nominal face dimensions and thickness of glazing. Structural support systems of wall to be modeled. Spacing, location, size and orientation of mullions. Operable components defined (doors) and included in model.	
350	<ul style="list-style-type: none"> • Mullion shapes and geometry defined. • Actual anchorage layouts and types defined. • Actual panel dimensions (including seating). 	
400	<ul style="list-style-type: none"> • Complete mullion extrusion profiles. • Interface details between wall systems (within) and wall and support systems. 	

C1010.40 21-03 10 10 40 Interior Demountable Partitions

Associated Masterformat Sections: 10 22 19 / 01 84 13 / 10 22 19.13 / 10 22 19.23 / 10 22 19.33
10 22 19.43 / 10 22 19.53

100	See C10	
200	See C1010	
300	See C1010.10	
350	See C1010.10 – also include hardware, accessories, and support structure.	
400	See C1010.10	

Reference Part II Attribute Tables for non-graphical information

C1010.50 21-03 10 10 50 Interior Operable Partitions

Includes: Track-supported, operable panels and partitions, top hung and floor supported, and manually and power operated. Includes auditorium partitions and dividers. Includes overhead supports.

Associated Masterformat Sections: 01 84 13 / 01 84 13 / 10 22 33 / 10 22 36 / 10 22 39
10 22 43

100	See C10	
200	See C1010	
300	Operable partition system modeled to include spatial requirements for open/storage position and closed position. Spatial requirements for structure (overhead or below) to be modeled.	
350	Major support elements (overhead or below) Mechanical connections	
400	All assembly components including tracks, panels, hardware and supports.	

C1010.70 21-03 10 10 70 Interior Screens

Portable and open dividers.

Associated Masterformat Sections: 10 22 23 / 10 82 23

[See [C1010.10](#)]

C1010.90 21-03 10 10 90 Interior Partitions Supplementary Components

Sound isolation components, firestopping, and expansion control to be included with interior partition elements above as appropriate.

These components are typically modeled as part of other assemblies listed in the tables above. Do not assign this Uniformat classification unless a supplementary component is modeled independently of another assembly.

Associated Masterformat Sections: 13 48 00 / 09 81 00 / 07 84 00 / 07 95 00

Reference Part II Attribute Tables for non-graphical information**C1020 21-03 10 20 Interior Windows**

Includes: Interior fixed or operable windows used singly and in multiples. Includes Interior Window Supplementary Components as appropriate. Includes metal, wood, plastic, and composite window units.

Associated Masterformat Sections: 08 50 00 / 01 84 13

100	See C10	
200	Windows approximate in terms of location, size, count and type. Units are modeled as a simple, monolithic component; or represented with simplified frame and glazing. Nominal unit size is provided.	

C1020.10 21-03 10 20 10 Interior Operating Windows

Includes: Interior fixed or operable windows used singly and in multiples. Includes Interior Window Supplementary Components as appropriate. Includes metal, wood, plastic, and composite window units.

Associated Masterformat Sections: 08 50 00

100	See C10	
200	See C1020	
300	Units are modeled based on specified location and nominal size. Outer geometry of window frame elements and glazing modeled. Operation is indicated.	
350	Rough opening is modeled in containing wall. Attachment method of window to structure Embed geometry	
400	Frame profiles Glazing sub-components (gaskets) Attachment components	

C1020.20 21-03 10 20 20 Interior Fixed Windows

Includes: Interior fixed or operable windows used singly and in multiples. Includes Interior Window Supplementary Components as appropriate. Includes metal, wood, plastic, and composite window units.

Associated Masterformat Sections: 08 50 00

C1020.50 21-03 10 20 50 Interior Special Function Windows

Includes interior windows with special characteristics for a special function.

Associated Masterformat Sections: 08 56 00 / 08 56 19 / 08 56 46 / 08 56 49 / 08 88 49 / 08 56 53 / 08 88 53 / 08 88 56 / 08 56 63 / 08 56 73

C1020.90 21-03 10 20 90 Interior Window Supplementary Components

Includes: Frames, sills, operating hardware, glazing to be included with interior window elements above as appropriate.

These components are typically modeled as part of other assemblies listed in the tables above. Do not assign this Uniformat classification unless a supplementary component is modeled independently of another assembly.

Associated Masterformat Sections: 08 75 00 / 08 80 00

Reference Part II Attribute Tables for non-graphical information**C1030 21-03 10 30 Interior Doors**

Includes: Interior door assemblies. Includes metal doors and frames, wood doors and frames, plastic doors, and composite doors. Includes Interior Door Supplementary Components as appropriate.

Associated Masterformat Sections: 08 10 00 / 01 84 13

100	See C10	
200	Units are modeled as a simple, monolithic component; or represented with simple frame and panel. Nominal unit size is provided.	

C1030.10 21-03 10 30 10 Interior Swinging Doors

Includes: Interior door assemblies. Includes metal doors and frames, wood doors and frames, plastic doors, and composite doors. Includes Interior Door Supplementary Components as appropriate.

Associated Masterformat Sections: 08 10 00

100	See C10	
200	See C1030	
300	Door assemblies modeled by type to include the following: <ul style="list-style-type: none"> • Specific door panels and frames (if applicable). • Operation is specified 	
350	Rough opening is modeled in containing wall. Major framing elements are modeled at jambs and head in containing wall. Operation or mechanism enclosures are modeled, if applicable.	
400	Actual frame/mullion extrusions. Actual panel size dimensions. All connections and interfaces modeled including brackets, supports, sealants, and thresholds.	

C1030.20 21-03 10 30 20 Interior Entrance Doors

Includes: Exterior personnel door assemblies at interior main entrances. Includes automatic, revolving, balanced, and other special operating entrance doors, and sliding storefront wall systems. Includes Interior Door Supplementary Components as appropriate when not part of storefront system.

Associated Masterformat Sections: 08 42 00 / 08 42 26 / 08 42 29 / 08 42 33 / 08 42 36
08 43 29

[See [B2050.10](#)]

C1030.25 21-03 10 30 25 Interior Sliding Doors

Associated Masterformat Sections: 08 11 73 / 08 32 00

[See [C1030.10](#)]

C1030.30 21-03 10 30 30 Interior Folding Doors

Associated Masterformat Sections: 08 35 13

[See [C1030.10](#)]

Reference Part II Attribute Tables for non-graphical information**C1030.40 21-03 10 30 40 Interior Coiling Doors**

Associated Masterformat Sections: 08 33 00 / 08 33 13

100	See C10	
200	See C1030	
300	Coiling door assemblies modeled by type to include the following: <ul style="list-style-type: none"> • Door panels with nominal dimensions. • Frames with nominal dimensions. • Hardware set functionality and types included in non-graphic information. • Clearance zones are modeled for operation of overhead doors. • Enclosures and motor housings are modeled with overall nominal dimensions. 	
350	Rough opening is modeled (if applicable). Major framing elements in wall are modeled at jambs and head. Other major structural support elements are modeled.	
400	All connections and interfaces modeled including brackets, supports, sealants, and thresholds.	

C1030.50 21-03 10 30 50 Interior Panel Doors*Includes: Interior large opening doors constructed of panels that move.*

Associated Masterformat Sections: 08 36 00 / 08 36 13 / 08 36 16 / 08 36 19 / 08 36 23

[See [C1030.40](#)]**C1030.70 21-03 10 30 70 Interior Special Function Doors***Includes: Interior door assemblies for a variety of special functions and applications involving a variety of operating methods. Includes Interior Door Supplementary Components as appropriate.*Associated Masterformat Sections: 08 30 00. / 08 34 13 / 08 34 19 / 08 34 33 / 08 34 36
08 34 46 / 08 34 49 / 08 88 49 / 08 34 53 / 08 42 33.13 / 08 88 53 / 08 88 56 / 08 34 59
08 34 63 / 08 34 73 / 08 38 00 / 08 39 00[See [C1030.40](#)]**C1030.80 21-03 10 30 80 Interior Access Doors and Panels***Includes: Doors and panels in walls, ceilings, and floors to provide access to concealed spaces. Includes frames and hardware.*

Associated Masterformat Sections: 08 31 00

[See [C1030.40](#)]**C1030.90 21-03 10 30 90 Interior Door Supplementary Components***Includes: Frames, hardware, glazing, and louvers that are part of door to be included with interior door elements above as appropriate.***These components are typically modeled as part of other assemblies listed in the tables above. Do not assign this Uniformat classification unless a supplementary component is modeled independently of another assembly.**

Associated Masterformat Sections: 08 10 00 / 08 30 00 / 08 71 00 / 08 80 00 / 08 91 26

Reference Part II Attribute Tables for non-graphical information**C1040 21-03 10 40 Interior Grilles and Gates***Includes: Interior operable grilles and gates Includes frames and hardware.*

100	See C10	
200	See C1030	

C1040.10 21-03 10 40 10 Interior Grilles

Associated Masterformat Sections: 08 11 74 / 08 33 00 / 08 35 16

100	See C10	
200	See C1030	
300	Grille assemblies modeled by type to include the following: <ul style="list-style-type: none"> Nominal size of unit. Required openness provided as non-graphic information. Operation is specified graphically. 	
350	Rough opening is modeled (if applicable). Major framing elements are modeled at jambs and head.	
400	All connections and interfaces modeled including brackets, supports, sealants, and thresholds.	

C1040.50 21-03 10 40 50 Interior Gates*Includes: Interior devices of solid or open construction, usually hinged, to provide moveable barrier for access through partition or other divider. Includes hardware, accessories, and finishing.*

Associated Masterformat Sections: 08 34 56 / 10 22 16

[See [C1040.10](#)]

Reference Part II Attribute Tables for non-graphical information**C1060 21-03 10 60 Raised Floor Construction**

Associated Masterformat Sections: 01 84 13 / 01 84 13 / 01 84 13 / 01 84 13 / 01 84 13

01 84 13 / 01 84 13 / 01 84 13 / 01 84 13

100	See C10	
200	Generic assembly that contains spatial allowance for support system and flooring material.	

C1060.10 21-03 10 60 10 Access Flooring

Includes: Free-standing, elevated accessible floor assembly forming an underfloor cavity that may be used for utility or other purposes.

Associated Masterformat Sections: 09 69 00

100	See C10	
200	See C1060	
300	Overall flooring assembly modeled by type to specified thickness/depth. Major openings such as shafts are modeled.	
350	Individual layers of assembly are modeled separately. All openings and penetrations are modeled. Expansion joints are modeled indicating specific width. Pedestals are modeled and located properly, if applicable.	
400	All assembly components are modeled including frame, floor tiles, pedestals, and cross bracing.	

C1060.30 21-03 10 60 30 Platform/Stage Floors

Includes: Fixed construction of raised floor for platforms or stages.

[See [C1060.10](#)]

Reference Part II Attribute Tables for non-graphical information**C1070 21-03 10 70 Suspended Ceiling Construction***Includes: Ceiling Suspension Components.*

Associated Masterformat Sections: 01 84 13 / 01 84 13

100	Ceiling construction is represented in other composite objects such as floors or rooms; or, schematic model elements that are not distinguishable by type or material. Assembly depth/thickness and locations still flexible.	
200	Generic assemblies indicative of overall scope and approximate thickness/system depth of suspended ceiling.	

C1070.10 21-03 10 70 10 Acoustical Suspended Ceilings*Includes: Suspended tiles and panels with specific characteristics for acoustical purposes.*

Associated Masterformat Sections: 09 51 00 / 09 81 00

100	See C1070	
200	See C1070	
300	Overall assembly modeled to specific system thickness including structural backing. Location of expansion or control joints indicated, but not modeled. Ceiling grid is shown as linework.	
350	Ceiling suspension grid is modeled. Structural backing members including bracing/lateral framing/kickers are modeled. Expansion or control joints are modeled to indicate specific width.	
400	All assembly components are modeled including tees, hangers, support structure, and tiles.	

Reference Part II Attribute Tables for non-graphical information

C1070.20 21-03 10 70 20 Suspended Plaster and Gypsum Board Ceilings

Includes: Suspended assemblies with plaster and gypsum board surfaces.

Associated Masterformat Sections: 09 20 00 / 09 22 26 / 09 81 00

100	See C1070	
200	See C1070	
300	Overall assembly modeled to specific system thickness including framing. Bulkheads Major penetrations are modeled.	
350	Major bracing elements such as kickers are modeled.	
400	All assembly components including furring channels, hangers, lath, plaster coats, and gypsum boards.	

C1070.50 21-03 10 70 50 Specialty Suspended Ceilings

Includes: Suspended specialty ceiling panels, units, and materials manufactured as finished

Associated Masterformat Sections: 09 54 00 / 09 56 00

[See [C1070.10](#) or [C1070.20](#)]

C1070.70 21-03 10 70 70 Special Function Suspended Ceilings

Includes: Suspended ceiling assemblies with an additional special function including integrated ceiling assemblies.

Associated Masterformat Sections: 09 57 00 / 09 57 53 / 09 58 00

[See [C1070.10](#) or [C1070.20](#)]

C1070.90 21-03 10 70 90 Ceiling Suspension Components

Includes: Hangers and framing to suspend ceiling and sound isolation components to be included with suspended ceiling construction elements above as appropriate.

These components are typically modeled as part of other assemblies listed in the tables above. Do not assign this Uniformat classification unless a supplementary component is modeled independently of another assembly.

Associated Masterformat Sections: 13 48 00

C1090 21-03 10 90 Interior Specialties

100	See C10	
200	Generic model elements with approximate nominal size. Placement and quantity remains flexible.	

C1090.10 21-03 10 90 10 Interior Railings and Handrails

Includes: Complete interior railing assemblies of various types including glazed railings.

Associated Masterformat Sections: 01 84 00 / 01 84 00 / 01 84 00 / 01 84 00 / 05 52 00
05 73 00 / 06 43 16 / 06 63 00 / 06 81 00

100	See C10	
200	Generic model element representing approximate overall height and location of railing/handrail.	
300	Railing/handrail systems modeled by type to include: <ul style="list-style-type: none"> • All horizontal rails 	

Reference Part II Attribute Tables for non-graphical information

	<ul style="list-style-type: none">All vertical posts/balusters	
350	Mounting/attachment components	
400	All assembly components including fasteners and supports.	

DRAFT

Reference Part II Attribute Tables for non-graphical information**C1090.15 21-03 10 90 15 Interior Louvers**

Includes: Interior louvers, and other items for ventilation which are not an integral part of the mechanical system. Includes operable and stationary louvers.

Associated Masterformat Sections: 08 91 00 / 01 84 00

100	See C10	
200	Generic model element that is indicative of approximate area and location of louver.	
300	Louver assembly modeled by type, indicative of area and location of intended louver/vent. Accurate frame and blade boundary areas Opening for louver is cut from host wall.	
350	Rough opening is modeled (if applicable) Major framing elements are modeled at jambs and head. Connection points are modeled.	
400	All connections and interfaces modeled including brackets, supports, and sealants.	

C1090.20 21-03 10 90 20 Information Specialties

Includes: Visual display units, display cases, directories, interior signage, telephone specialties, and informational kiosks.

Associated Masterformat Sections: 10 10 00 / 10 11 00 / 10 11 13 / 10 11 16 / 10 11 23

10 11 33 / 10 11 36 / 10 11 39 / 10 11 43 / 10 11 46 / 10 12 00 / 10 13 00 / 10 14 00 / 10 17 00 / 10 18 00

[See [Fundamental LOD Definitions](#)]

C1090.25 21-03 10 90 25 Compartments and Cubicles

Includes: Manufactured compartments and cubicles for specific purposes. Includes toilet compartments, shower stalls, etc.

Associated Masterformat Sections: 10 21 00 / 10 21 13 / 10 21 16 / 10 21 23 / 10 28 19

[See [Fundamental LOD Definitions](#)]

C1090.30 21-03 10 90 30 Service Walls

Includes: Wall assemblies and wall-mounted units incorporating services.

Associated Masterformat Sections: 10 25 00 / 10 25 13 / 10 25 16

[See [C1010.10](#)]

C1090.35 21-03 10 90 35 Wall and Door Protection

Includes: Manufactured protective devices for walls and doors. Includes corner guards, bumper guards, and protective wall covering.

Associated Masterformat Sections: 10 26 00 / 10 26 13 / 10 26 16 / 10 26 23 / 10 26 33

[See [Fundamental LOD Definitions](#)]

C1090.40 21-03 10 90 40 Toilet, Bath and Laundry Accessories

Includes: Manufactured items for use in conjunction with toilets, baths, and laundries.

Associated Masterformat Sections: 10 28 00 / 10 28 13 / 10 28 16 / 10 28 23

[See [Fundamental LOD Definitions](#)]

C1090.45 21-03 10 90 45 Interior Gas Lighting

Associated Masterformat Sections: 10 84 16

Reference Part II Attribute Tables for non-graphical information

[See [Fundamental LOD Definitions](#)]

C1090.50 21-03 10 90 50 Fireplaces and Stoves

Includes: Masonry fireplaces and manufactured and fabricated fireplaces, stoves, chimneys, dampers, and specialties for use in construction of fireplaces and stove units.

Associated Masterformat Sections: 10 30 00 / 04 50 00 / 04 57 00 / 10 31 00 / 10 31 13
10 32 00 / 10 35 00

[See [Fundamental LOD Definitions](#)]

C1090.60 21-03 10 90 60 Safety Specialties

Includes: Accessories that provide emergency aid.

Associated Masterformat Sections: 10 40 00 / 10 41 00 / 10 43 00

[See [Fundamental LOD Definitions](#)]

C1090.70 21-03 10 90 70 Storage Specialties

Includes: Lockers, postal specialties, storage specialties, and wardrobe and closet specialties.

Associated Masterformat Sections: 10 50 00 / 10 51 00 / 10 51 53 / 10 55 00 / 10 55 23 / 10 55 91 / 10 56 00 / 10 56 29 / 10
56 33 / 10 57 00 / 10 57 13 / 10 57 33

[See [Fundamental LOD Definitions](#)]

C1090.90 21-03 10 90 90 Other Interior Specialties

Includes: Pest control devices, flags and banners, security mirrors and domes, and scales.

Associated Masterformat Sections: 10 80 00 / 10 81 00 / 10 81 16 / 10 81 19 / 10 83 00 / 08 83 00 / 10 86 00 / 10 88 00

[See [Fundamental LOD Definitions](#)]

Reference Part II Attribute Tables for non-graphical information

C20 21-03 20 Interior Finishes

Associated Masterformat Sections: 01 84 19

100	Non-graphic information attached to model elements providing assumptions about proposed finish materials. See Part II
-----	---

C2010 21-03 20 10 Wall Finishes

Includes: Wall finishes applied over solid substrates. Includes Wall Finish Supplementary Components as appropriate.

Associated Masterformat Sections: 09 70 00 / 01 84 19 / 01 84 19 / 01 84 19 / 01 84 19 / 01 84

100	See C20
200	Generic materials other than sheet goods and coatings by type (e.g. tile or paneling), approximate thickness and scope in elevation.
300	Materials are modeled based on specific types (e.g. Tile type CT-1). Thickness and scope of finishes other than sheet goods and coatings are accurately modeled. Sheet goods and coatings may be specified in Part II related to interior partitions.
350	Additional non-graphic information to include: <ul style="list-style-type: none"> • Manufacturer • Model
400	Pattern layouts Expansion/control joints Edges

C2010.10 21-03 20 10 10 Tile Wall Finish

Includes: Manufactured surfacing units of impervious, vitreous, semi-vitreous, and non-vitreous materials; glazed, unglazed, conductive, and textured surfaces.

Associated Masterformat Sections: 09 30 00

[See [C2010](#)]

C2010.20 21-03 20 10 20 Wall Paneling

Includes: Covering or cladding of interior walls with paneling. Includes associated furring, fastening, and trim.

Associated Masterformat Sections: 06 42 00 / 06 25 00 / 06 26 00 / 06 64 00 / 06 83 00

[See [C2010](#)]

C2010.30 21-03 20 10 30 Wall Coverings

Includes: Wall coverings applied over solid substrates. Includes vinyl-coated fabric, vinyl and cork wall coverings; wall papers; and flexible wood sheets.

Associated Masterformat Sections: 09 72 00 / 09 74 00

[See [C2010](#)]

C2010.35 21-03 20 10 35 Wall Carpeting

Includes: Wall carpet materials and accessories.

Associated Masterformat Sections: 09 73 00

Reference Part II Attribute Tables for non-graphical information

C2010.50 21-03 20 10 50 Stone Facing

Includes: Natural stone applied as an interior veneer surface.

Associated Masterformat Sections: 09 75 00

[See [C2010](#)]

C2010.60 21-03 20 10 60 Special Wall Surfacing

Includes: Manufactured decorative interior wall surface products including plastic blocks.

Associated Masterformat Sections: 09 77 00 / 09 77 13 / 09 77 23 / 09 76 00

[See [C2010](#)]

C2010.70 21-03 20 10 70 Wall Painting and Coating

Includes: Interior painting and coating with transparent and opaque finishes. Includes stains, varnishes, lacquers, primers, fillers, paint removers, and waxes, and preparation of surfaces.

Associated Masterformat Sections: 09 90 00

[See [C2010](#)]

C2010.80 21-03 20 10 80 Acoustical Wall Treatment

Includes: Sound absorbing, reflecting, and diffusing wall units, and accessories.

Associated Masterformat Sections: 09 83 13 / 09 84 00 / 09 84 33

[See [C2010](#)]

C2010.90 21-03 20 10 90 Wall Finish Supplementary Components

Includes: Furring to be included with wall finish elements above as appropriate.

Associated Masterformat Sections: 06 10 00 / 09 22 13

[See [C1010](#)]

C2020 21-03 20 20 Interior Fabrications

Includes: Interior fabrications of a variety of materials formed to various profiles for a variety of purposes including column covers.

Associated Masterformat Sections: 03 49 00 / 05 50 00 / 05 58 13 / 05 70 00 / 06 44 00 / 06 60 00 / 06 61 00 / 06 80 00 / 09 27 00

[See [Fundamental LOD Definitions](#)]

C2030 21-03 20 30 Flooring

Includes: Flooring Supplementary Components as appropriate.

Associated Masterformat Sections: 09 60 00 / 01 84 19

[See [C2010](#)]

C2040 21-03 20 40 Stair Finishes

Includes: Stair tread, riser, and landing finish of various materials.

Associated Masterformat Sections: 01 84 19

[See [C2010](#)]

C2050 21-03 20 50 Ceiling Finishes

Includes: Finishes applied to interior ceiling substrates. Ceiling finishes may be applied to suspended ceiling construction. Includes Ceiling Finish Supplementary Components as appropriate.

Associated Masterformat Sections: 09 50 00 / 01 84 19

Reference Part II Attribute Tables for non-graphical information**D 21-04 00 00 SERVICES**

Associated Masterformat Sections: 01 86 00

D10 21-04 10 Conveying

Associated Masterformat Sections: 01 85 00 / 14 00 00

100	Schematic model elements that are not distinguishable by type or material. Component sizes and locations still flexible.	
-----	---	--

D1010 21-04 10 10 Vertical Conveying Systems

Associated Masterformat Sections:

100	See D10	
200	Generic representation of the system envelope, including critical path of travel zones.	

D1010.10 21-04 10 10 10 Elevators

Includes: Passenger and freight elevators of all types, including cars, enclosures, controls, safety equipment, hoist way equipment, and elevator machinery. Includes associated metal fabrications including pit ladders.

Associated Masterformat Sections: 01 85 00 / 14 20 00 / 14 21 13 / 14 21 23 / 14 21 33 / 14 21 43 / 14 24 13 / 14 24 23 / 14 24 33 / 14 24 43 / 14 26 00 / 14 27 00 / 14 28 00

100	See D10	
200	See D1010	
300	Specific system elements modeled by type, including all path of travel zones. Pits and/or control rooms and associated equipment to be modeled if applicable. Major structural support elements modeled. Connections to mechanical or electrical services.	
350	Sizing adjusted to the actual manufacturer specifications. Guiding tracks/rails Service/access zones	
400	All connections, supports, framing, and other supplementary components.	

Reference Part II Attribute Tables for non-graphical information

D1010.20 21-04 10 10 20 Lifts

Includes: Vertical or inclined lifts and related equipment for a variety of purposes. Sidewalk lifts include doors.

Associated Masterformat Sections: 01 85 00 / 14 40 00 / 14 41 00 / 14 42 00 / 14 43 00
14 43 13 / 14 43 16 / 14 44 00 / 14 45 00

[See [D1010.10](#)]

D1010.30 21-04 10 10 30 Escalators

Includes: Passenger conveying systems composed of moving treads installed in inclined position including associated components, hardware, controls, safety equipment, and related items.

Associated Masterformat Sections: 01 85 00 / 14 31 00

[See [D1010.10](#)]

D1010.50 21-04 10 10 50 Dumbwaiters

Includes: Packaged and field assembled, motorized and hand- operated dumbwaiters including associated components for book lifts, cart lifts, and other applications. Systems include associated components, hardware, controls, and safety equipment.

Associated Masterformat Sections: 01 85 00 / 14 10 00

[See [D1010.10](#)]

D1010.60 21-04 10 10 60 Moving Ramps

Includes: Passenger conveying systems composed of moving belts installed in inclined position including associated components, hardware, controls, safety equipment, and related items.

Associated Masterformat Sections: 01 85 00 / 14 33 00

[See [D1010.10](#)]

D1030 21-04 10 30 Horizontal Conveying

Associated Masterformat Sections: 01 85 00

[See [D1010.10](#)]

D1030.10 21-04 10 30 10 Moving Walks

Includes: Passenger conveying systems composed of moving belts installed in horizontal position including associated components, hardware, controls, safety equipment, and related items.

Associated Masterformat Sections: 01 85 00 / 14 32 00

[See [D1010.10](#)]

D1030.30 21-04 10 30 30 Turntables

Includes: Structural turntables for various applications.

Associated Masterformat Sections: 01 85 00 / 14 70 00 / 14 71 00 / 14 71 11 / 14 72 00
14 72 25 / 14 73 00 / 14 73 59 / 14 74 00 / 14 74 61

[See [D1010.10](#)]

D1030.50 21-04 10 30 50 Passenger Loading Bridges

Includes: Operating bridges for loading and unloading of passengers to and from aircraft and ships.

Associated Masterformat Sections: 01 85 00 / 34 77 13

[See [D1010.10](#)]

D1030.70 21-04 10 30 70 People Movers

Includes: Single rail vehicles suspended from or straddle the guideway. Includes associated track, equipment, controls, and accessories. Includes: Steep cable railways in which ascending cars counterbalance descending cars. Includes associated track,

Reference Part II Attribute Tables for non-graphical information

cable. Includes: Steep slope transportation system utilizing moving cable. Includes associated cable, support structures, equipment, controls, and accessories.

Associated Masterformat Sections: 01 85 00 / 34 12 00 / 34 13 00 / 34 14 00

[See [D1010.10](#)]

D1050 21-04 10 50 Material Handling

Associated Masterformat Sections: 01 85 00

100	See D10	
200	Generic representation of the material handling system envelope, including critical path of travel zones.	

D1050.10 21-04 10 50 10 Cranes

Includes: Hoisting towers, cranes, crane rails, and related accessories.

Associated Masterformat Sections: 41 22 13

100	See D10	
200	See D1050	
300	Specific system elements modeled by type, including all path of travel/boom swing zones. Lay-down/pick-up zones are modeled. Major structural support elements modeled. Connections to mechanical or electrical services.	
350	Sizing adjusted to the actual manufacturer specifications. Guiding tracks/rails Service/access zones	
400	All connections, supports, framing, and other supplementary components.	

D1050.20 21-04 10 50 20 Hoists

Includes: Manual and motor operated hoists and related accessories.

Associated Masterformat Sections: 41 22 23

[See [D1050.10](#)]

Reference Part II Attribute Tables for non-graphical information**D1050.30 21-04 10 50 30 Derricks***Includes: Manual and motor operated derricks and related accessories.*

Associated Masterformat Sections: 41 22 33

[See [D1050.10](#)]**D1050.40 21-04 10 50 40 Conveyors***Includes: Automatic guided vehicles, conveyors, diverters, and chutes. Includes controls and accessories.*

Associated Masterformat Sections: 41 21 00

[See [D1050.10](#)]**D1050.50 21-04 10 50 50 Baggage Handling Equipment***Includes: Operating equipment for handling, scanning, and weighing of baggage at terminals. Includes controls and accessories.*

Associated Masterformat Sections: 34 77 16

100	See D10	
200	See D1050	
300	See Fundamental LOD Definitions	
350	See Fundamental LOD Definitions	
400	See Fundamental LOD Definitions	

D1050.60 21-04 10 50 60 Chutes*Includes: Chutes which support the operation of the building or structure.*

Associated Masterformat Sections: 14 91 00 / 14 91 13 / 14 91 23 / 14 91 33 / 14 91 82

[See [D1050.10](#)]

Reference Part II Attribute Tables for non-graphical information

D1050.70 21-04 10 50 70 Pneumatic Tube Systems

Includes: Pneumatically operated tube system for the delivery of small items within a facility. Includes controls and accessories.

Associated Masterformat Sections: 14 92 00

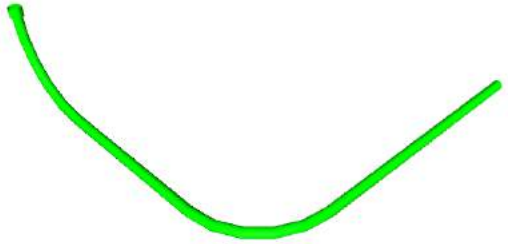
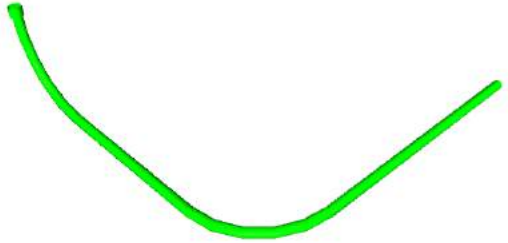
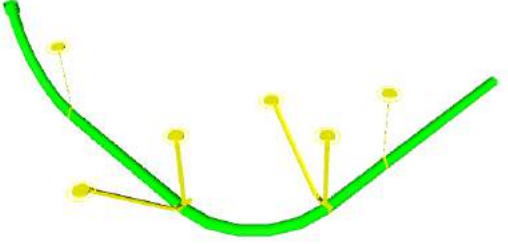
<p>100</p>	<p>Diagrammatic elements or quantitative call outs; conceptual and/or schematic flow diagrams;</p>	 <p>103 D1050.70-LOD-100 Pneumatic Tube Systems</p>
<p>200</p>	<p>Generic elements; schematic layout with approximate size, shape, and location of equipment and tubing;</p>	 <p>104 D1050.70-LOD-200 Pneumatic Tube Systems</p>
<p>300</p>	<p>Modeled as design-specified elements; specified size, shape, spacing, and location of equipment and tubing; approximate allowances for spacing and clearances required for all specified hangers, supports, vibration and seismic control that are to be utilized in the layout of all equipment and tubing; actual access/code clearance requirements modeled.</p>	 <p>105 D1050.70-LOD-300 Pneumatic Tube Systems</p>
<p>350</p>	<p>Modeled as <i>actual construction</i> elements; actual size, shape, spacing, and location/connections of equipment and tubing; actual size, shape, spacing, and clearances required for all hangers, supports, vibration and seismic control that are utilized in the layout of all equipment and tubing; floor and wall penetrations modeled.</p>	 <p>106 D1050.70-LOD-350 Pneumatic Tube Systems</p>

Reference Part II Attribute Tables for non-graphical information

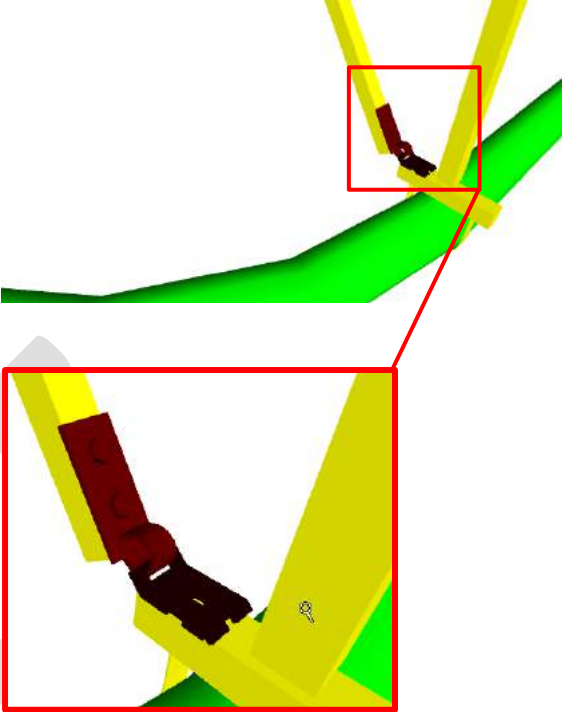
400	Supplementary components added to the model required for fabrication and field installation	 <p>107 D1050.70-LOD-400 Pneumatic Tube Systems</p>
-----	---	---

D1080 21-04 10 80 Operable Access Systems

Associated Masterformat Sections:

[See [Fundamental LOD Definitions](#)]

D1080.10 21-04 10 80 10 Suspended Scaffolding

Includes: Suspended scaffolding when part of the completed project.

Associated Masterformat Sections: 14 81 00

[See [Fundamental LOD Definitions](#)]

D1080.20 21-04 10 80 20 Rope Climbers

Includes: Powered rope climbers to access exterior façade.

Associated Masterformat Sections: 14 82 00

[See [Fundamental LOD Definitions](#)]

D1080.30 21-04 10 80 30 Elevating Platforms

Includes: Fixed elevating platforms to provide a movable elevated working platform for people and materials.

Associated Masterformat Sections: 14 83 00

[See [Fundamental LOD Definitions](#)]

Reference Part II Attribute Tables for non-graphical information**D1080.40 21-04 10 80 40 Powered Scaffolding***Includes: Powered scaffolding when part of the completed project.*

Associated Masterformat Sections: 14 84 00 / 14 84 13

[See [Fundamental LOD Definitions](#)]**D1080.50 21-04 10 80 50 Building Envelope Access**

Associated Masterformat Sections: 11 24 23

[See [Fundamental LOD Definitions](#)]**D20 21-04 20 Plumbing**

Associated Masterformat Sections: 01 86 16 / 22 00 00

100	Diagrammatic or schematic model elements; conceptual and/or schematic layout/flow diagram; design performance parameters as defined in the BIMXP to be associated with model elements as non-graphic information.	
-----	---	--

D2010 21-04 20 10 Domestic Water Distribution*Includes: Facility domestic water distribution system. Include Domestic Water Distribution Supplementary Components as appropriate.*

Associated Masterformat Sections: 01 86 16 / 22 11 00

100	See D20	
200	Schematic layout of generic model elements with approximate size, shape, and location of elements; shaft requirements modeled;	

Reference Part II Attribute Tables for non-graphical information

D2010.10 21-04 20 10 10 Facility Potable-Water Storage Tanks

Includes: Tanks for storage of potable water serving a facility and located within, on, under, or closely associated with a structure.

Associated Masterformat Sections: 22 12 00

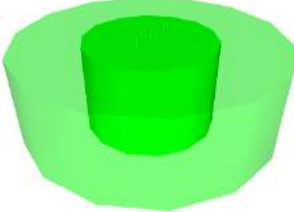
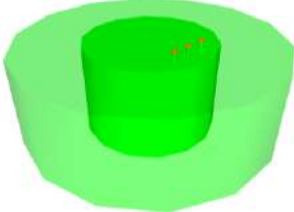
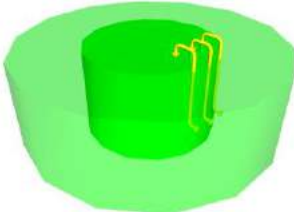
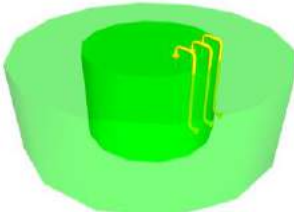
100	See D20	
200	Schematic layout with approximate size, shape, and location of tank(s);	 <p><i>108 D2010.10-LOD-200 Facility Potable-Water Storage Tanks</i></p>
300	Modeled as design-specified size, shape, spacing, and location of tank(s); approximate allowances for spacing and clearances required for all specified anchors, supports, vibration and seismic control that are utilized in the layout of tanks(s); actual access/code clearance requirements modeled.	 <p><i>109 D2010.10-LOD-300 Facility Potable-Water Storage Tanks</i></p>
350	Modeled as actual construction elements <i>size and shape, spacing, and location/connections</i> of tank(s) Actual size and shape, spacing, and clearances required for all specified anchors, supports, vibration and seismic control that are utilized in the layout of tanks(s).	 <p><i>110 D2010.10-LOD-350 Facility Potable-Water Storage Tanks</i></p>
400	Supplementary components added to the model required for fabrication and field installation.	 <p><i>111 D2010.10-LOD-400 Facility Potable-Water Storage Tanks</i></p>

Reference Part II Attribute Tables for non-graphical information

D2010.20 21-04 20 10 20 Domestic Water Equipment

Includes: Equipment for domestic water distribution system. Includes: Equipment for the softening of domestic water. Includes: Equipment for the filtering of domestic water. Includes: Equipment to heat domestic water. Includes electric and fuel-fired equipment. Includes: Equipment to heat domestic water by means of heat exchange.

Associated Masterformat Sections: 22 11 23 / 22 31 00 / 22 32 00 / 22 33 00 / 22 34 00 / 22 35 00

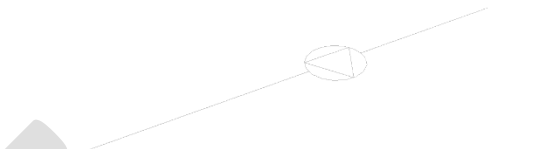
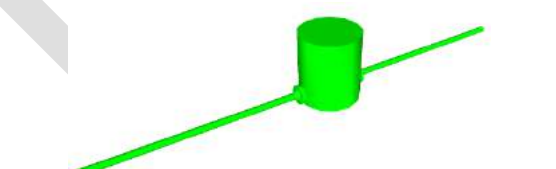
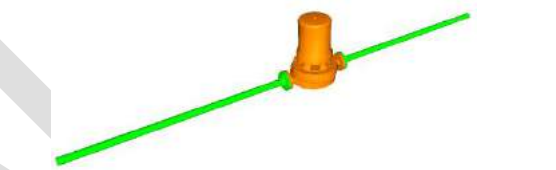
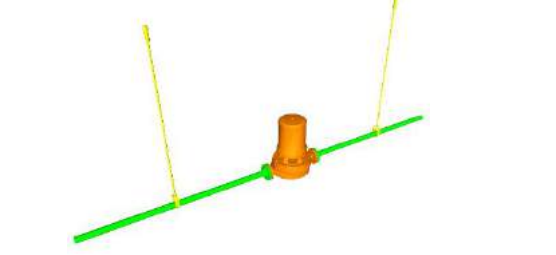
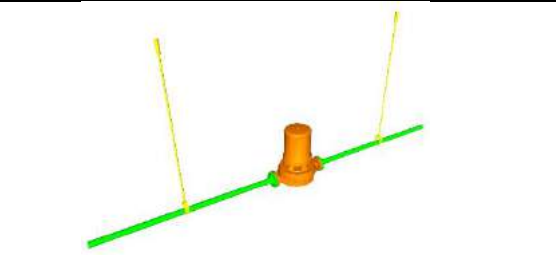
<p>100</p>	<p>See D20</p>	 <p>112 D2010.20-LOD-100 Domestic Water Equipment</p>
<p>200</p>	<p>Schematic layout with approximate size, shape, and location of equipment; approximate access/code clearance requirements modeled;</p>	 <p>113 D2010.20-LOD-200 Domestic Water Equipment</p>
<p>300</p>	<p>Modeled as design-specified size, shape, spacing, and location of equipment; approximate allowances for spacing and clearances required for all specified anchors, supports, vibration and seismic control that are utilized in the layout of equipment; actual access/code clearance requirements modeled.</p>	 <p>114 D2010.20-LOD-300 Domestic Water Equipment</p>
<p>350</p>	<p>Modeled as actual construction elements size, shape, spacing, and location/connections of equipment; Actual size, shape, spacing, and clearances required for all specified anchors, supports, vibration and seismic control that are utilized in the layout of equipment.</p>	 <p>115 D2010.20-LOD-350 Domestic Water Equipment</p>
<p>400</p>	<p>See D2010.10</p>	 <p>116 D2010.20-LOD-400 Domestic Water Equipment</p>

D2010.40 21-04 20 10 40 Domestic Water Piping

Includes: Piping, valves, and specialties associated with domestic water distribution located within, under, or closely associated with a structure. Includes circulating pumps. May include: Water service from the structure to the utility water service line.

Reference Part II Attribute Tables for non-graphical information

Associated Masterformat Sections: 22 11 16 / 22 11 19

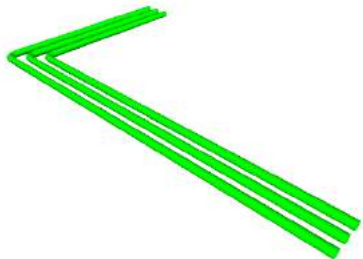
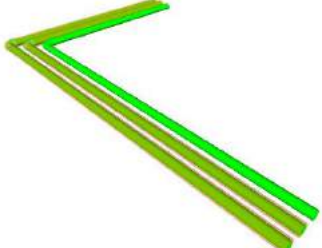
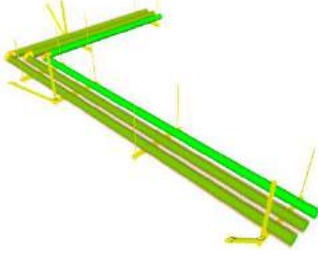
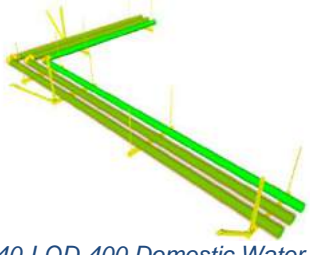
100	Diagrammatic or schematic model elements; conceptual and/or schematic flow diagrams; design performance parameters as defined in the BIMXP to be associated with model elements as non-graphic information.	
200	Schematic layout with approximate size, shape, and location of mains and risers; shaft requirements modeled;	 <p>117 D2010.40-LOD-200 Domestic Water Piping</p>
300	Modeled as design-specified size, shape, spacing, and location of pipe, valves, fittings, and insulation for risers, mains, and branches; approximate allowances for spacing and clearances required for all specified hangers, supports, vibration and seismic control that are to be utilized in the layout of all risers, mains, and branches; actual access/code clearance requirements modeled.	 <p>118 D2010.40-LOD-300 Domestic Water Piping</p>
350	Modeled as actual construction elements; Actual size, shape, spacing, and location/connections of pipe, valves, fittings, and insulation for risers, mains, and branches; Actual size, shape, spacing, and clearances required for all hangers, supports, vibration and seismic control that are utilized in the layout of all risers, mains, and branches; Actual floor and wall penetrations modeled.	 <p>119 D2010.40-LOD-350 Domestic Water Piping</p>
400	See D2010.10	 <p>120 D2010.40-LOD-400 Domestic Water Piping</p>





D2010.60 21-04 20 10 60 Plumbing Fixtures

Includes: Terminal devices on the domestic water plumbing system. Includes rough-in piping, trim, fittings, and connection to vent piping.

Associated Masterformat Sections: 22 40 00 / 22 41 00 / 22 41 13 / 22 41 16 / 22 41 19
22 41 23 / 22 41 26 / 22 41 36 / 22 41 39 / 22 42 00 / 22 42 13 / 22 42 16 / 22 42 19
22 42 23 / 22 42 26 / 22 42 29 / 22 42 33 / 22 42 36 / 22 42 39 / 22 42 43 / 22 43 00

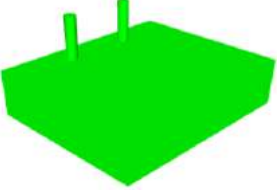
Reference Part II Attribute Tables for non-graphical information

22 43 13 / 22 43 16 / 22 43 19 / 22 43 23 / 22 43 39 / 22 43 43 / 22 45 00 / 22 45 13
 22 45 16 / 22 45 26 / 22 45 29 / 22 45 33 / 22 45 36 / 22 46 00 / 22 46 13 / 22 46 16
 22 46 39 / 22 46 43 / 22 46 53 / 22 47 00 / 22 47 13 / 22 47 23

100	See D20	
200	Schematic layout with approximate size, shape, and location of fixtures; carrier and wall width requirements modeled;	 <p>121 D2010.60-LOD-200 Plumbing Fixtures</p>
300	Modeled as design-specified size, shape, spacing, and location of fixtures; Approximate allowances for spacing and clearances required for all specified supports that are to be utilized in the layout of all fixtures; Actual access/code clearance requirements modeled.	 <p>122 D2010.60-LOD-200 Plumbing Fixtures</p>
350	Modeled as actual construction elements size, shape, spacing, and location/connections of fixtures/carriers; Actual size, shape, spacing, and clearances required for all supports that are utilized in the layout of all fixtures.	 <p>123 D2010.60-LOD-350 Plumbing Fixtures</p>
400	See D2010.10	 <p>124 D2010.60-LOD-400 Plumbing Fixtures</p>

D2010.90

21-04 20 10 90

Domestic Water Distribution Supplementary

Components

Includes: Common work results for plumbing, plumbing insulation, and instrumentation. Includes: expansion fittings, meters, gages, valves, hangers, supports, heat tracing, vibration and seismic controls.

These components are typically modeled as part of other assemblies listed in the tables above. Do not assign this Uniformat classification unless a supplementary component is modeled independently of another assembly.

Reference Part II Attribute Tables for non-graphical information

Associated Masterformat Sections: 05 45 13 / 22 05 00 / 22 05 16 / 22 05 19 / 22 05 23
22 05 29 / 22 05 33 / 22 05 48 / 22 05 53 / 22 07 00 / 22 09 00

D2020 21-04 20 20 Sanitary Drainage

Includes: Facility sanitary sewerage system located within, under, or closely associated with a structure. Include Sanitary Drainage Supplementary Components as appropriate.

Associated Masterformat Sections: 01 86 16 / 22 13 00

100	See D20	
200	See D2010	





DRAFT

Reference Part II Attribute Tables for non-graphical information

D2020.10 21-04 20 20 10 Sanitary Sewerage Equipment

Includes: Interceptor, separator, pumps, and septic tanks that are part of facility sanitary sewerage system.

Associated Masterformat Sections: 22 13 23 / 22 13 26 / 22 13 29 / 22 13 33 / 22 13 36
22 13 43 / 22 13 53

100	See D20	
200	Schematic layout with approximate size, shape, and location of equipment;	 <p><i>125 D2020.10-LOD-200 Sanitary Sewerage Equipment</i></p>
300	<p>Modeled as design specified size, shape, spacing, and location of equipment;</p> <p>Approximate allowances for spacing and clearances required for all specified anchors, supports, vibration and seismic control that are utilized in the layout of equipment; actual access/code clearance requirements modeled.</p> <p>Actual access/code clearance requirements modeled.</p>	 <p><i>126 D2020.10-LOD-300 Sanitary Sewerage Equipment</i></p>
350	Actual size, shape, spacing, and clearances required for all specified anchors, supports, vibration and seismic control that are utilized in the layout of equipment;	 <p><i>127 D2020.10-LOD-350 Sanitary Sewerage Equipment</i></p>
400	Supplementary components added to the model required for fabrication and field installation	 <p><i>128 D2020.10-LOD-400 Sanitary Sewerage Equipment</i></p>

D2020.30 21-04 20 20 30 Sanitary Sewerage Piping

Includes: Sanitary waste and vent piping system within and under structures. May Include: Sanitary piping from the structure to the utility sanitary sewer.

Reference Part II Attribute Tables for non-graphical information

Associated Masterformat Sections: 22 13 13 / 22 13 16 / 22 13 19 / 22 05 73 / 22 05 76

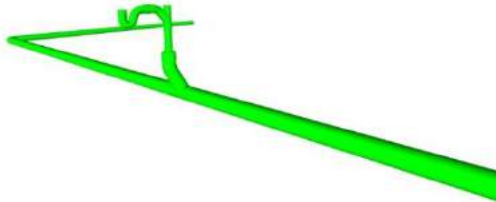
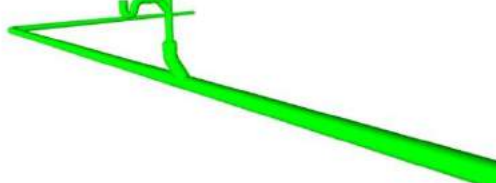
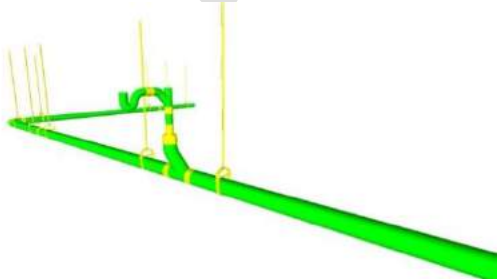
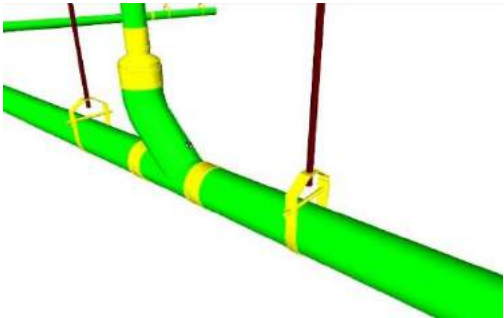
100	See D20	
200	Schematic layout with approximate size, shape, and location of mains and risers; shaft requirements modeled;	 <p>129 D2020.30-LOD-200 Sanitary Sewerage Piping</p>
300	<p>Modeled as design-specified size, shape, spacing, location, and slope of pipe, valves, fittings, and insulation for risers, mains, and branches;</p> <p>Approximate allowances for spacing and clearances required for all specified hangers, supports, vibration and seismic control that are to be utilized in the layout of all risers, mains, and branches;</p> <p>Actual access/code clearance requirements modeled</p>	 <p>130 D2020.30-LOD-300 Sanitary Sewerage Piping</p>
350	<p>Modeled as actual construction elements;</p> <p>Actual size, shape, spacing, location, connections, and slope of pipe, valves, fittings, and insulation for risers, mains, and branches;</p> <p>Actual size, shape, spacing, and clearances required for all hangers, supports, vibration and seismic control that are utilized in the layout of all risers, mains, and branches;</p> <p>Actual floor and wall penetrations modeled.</p>	 <p>131 D2020.30-LOD-350 Sanitary Sewerage Piping</p>
400	See D2020.10	 <p>132 D2020.30-LOD-400 Sanitary Sewerage Piping</p>

Reference Part II Attribute Tables for non-graphical information

D2020.90 21-04 20 20 90 Sanitary Drainage Supplementary Components

Includes: Common work results for plumbing, plumbing insulation, and instrumentation and control for plumbing to be included with sanitary drainage elements above as appropriate. Includes expansion fittings, meters, gages, valves, hangers, supports, heat tracing, vibration and seismic controls.

These components are typically modeled as part of other assemblies listed in the tables above. Do not assign this Uniformat classification unless a supplementary component is modeled independently of another assembly.

Associated Masterformat Sections: 05 45 13 / 22 05 00 / 22 05 16 / 22 05 19 / 22 05 23
22 05 29 / 22 05 33 / 22 05 48 / 22 05 53 / 22 07 00 / 22 09 00

D2030 21-04 20 30 Building Support Plumbing Systems

Includes: Facility storm water drainage and gray water systems. Include Building Support Plumbing System Supplementary Components as appropriate.

Associated Masterformat Sections: 01 86 16 / 22 14 00

100	See D20	
200	See D2010	

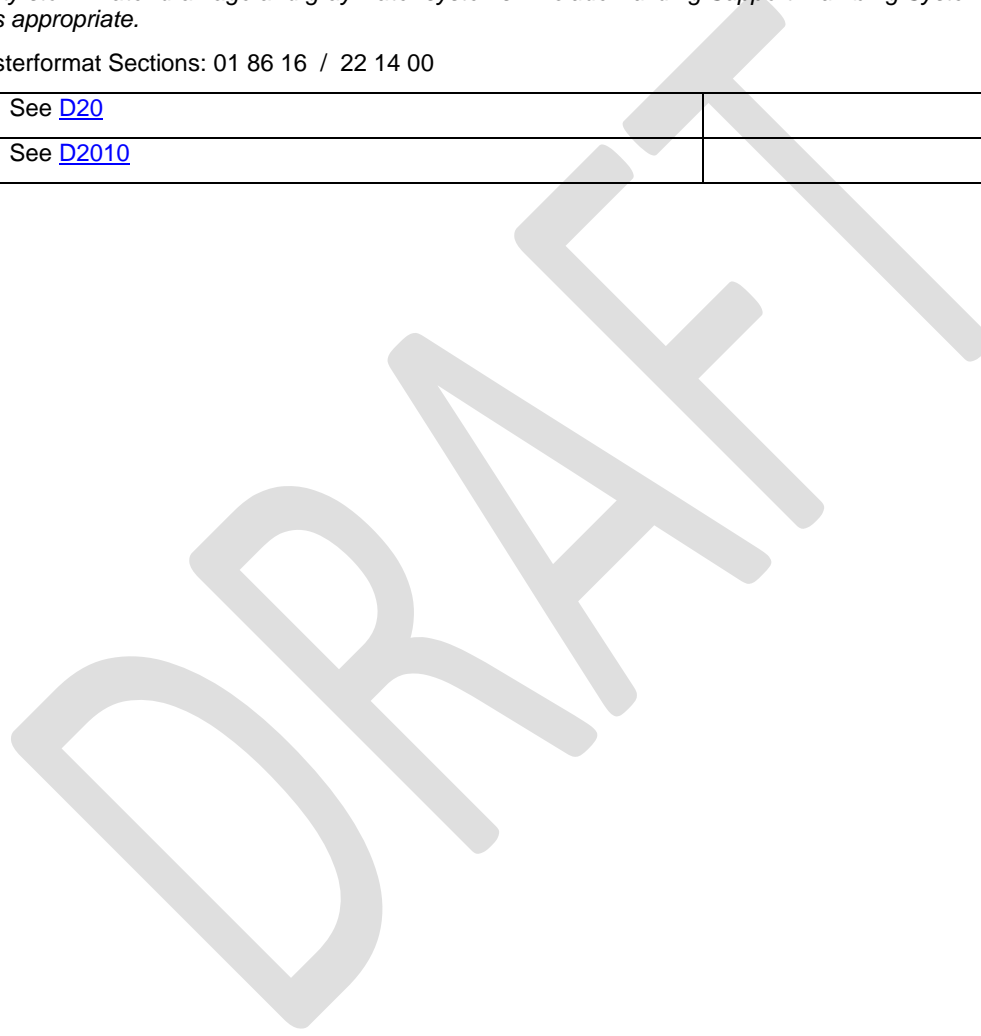





Reference Part II Attribute Tables for non-graphical information

D2030.10 21-04 20 30 10 Stormwater Drainage Equipment

Includes: Drainage pumps, and sump pumps that are part of stormwater drainage system.

Associated Masterformat Sections: 22 14 29 / 22 14 33 / 22 14 36 / 22 14 53

100	Diagrammatic or schematic model elements; conceptual and/or schematic layout;	
200	Schematic layout with approximate size, shape, and location of equipment; approximate access/code clearance requirements modeled;	 <p><i>133 D2030.10-LOD-200 Stormwater Drainage Equipment</i></p>
300	Modeled as design-specified size, shape, spacing, and location of equipment; approximate allowances for spacing and clearances required for all specified anchors, supports, vibration and seismic control that are utilized in the layout of equipment; access/code clearance requirements modeled.	 <p><i>134 D2030.10-LOD-300 Stormwater Drainage Equipment</i></p>
350	Modeled as actual construction elements size, shape, spacing, and location/connections of equipment, actual size, shape, spacing, and clearances required for all specified anchors, supports, vibration and seismic control that are utilized in the layout of equipment; actual access/code clearance requirements modeled.	 <p><i>135 D2030.10-LOD-350 Stormwater Drainage Equipment</i></p>
400	Supplementary components added to the model required for fabrication and field installation.	 <p><i>136 D2030.10-LOD-400 Stormwater Drainage Equipment</i></p>

Reference Part II Attribute Tables for non-graphical information

D2030.20 21-04 20 30 20 Stormwater Drainage Piping

Includes: Storm drainage piping system within, under, or closely associated with a structure. Includes storm drains for areas closely associated with a structure such as courtyards, plazas, and loading dock areas. May Include: Storm drainage piping from the structure to the utility storm drain.

Associated Masterformat Sections: 22 05 73 / 22 05 76 / 22 14 13 / 22 14 16 / 22 14 23

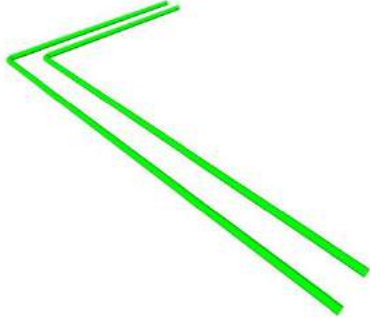
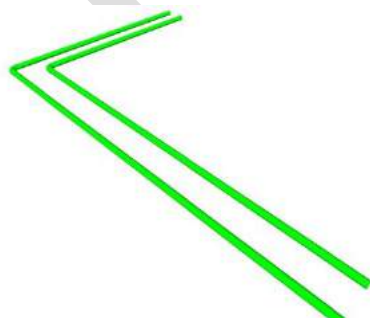
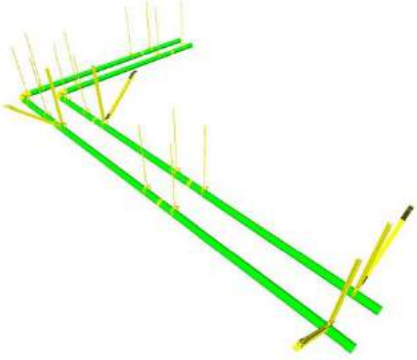
100	See D20	
200	Schematic layout with approximate size, shape, and location of mains and risers; shaft requirements modeled;	 <p><i>137 D2030.20-LOD-200 Stormwater Drainage Piping</i></p>
300	Modeled as design-specified size, shape, spacing, location, and slope of pipe, valves, fittings, and insulation for risers, mains, and branches; approximate allowances for spacing and clearances required for all specified hangers, supports, vibration and seismic control that are to be utilized in the layout of all risers, mains, and branches; access/code clearance requirements modeled.	 <p><i>138 D2030.20-LOD-300 Stormwater Drainage Piping</i></p>
350	Modeled as actual size, shape, spacing, location, connections, and slope of pipe, valves, fittings, and insulation for risers, mains, and branches; actual size and shape, spacing, and clearances required for all hangers, supports, vibration and seismic control that are utilized in the layout of all risers, mains, and branches; Actual access/code clearance requirements modeled. actual floor and wall penetrations modeled.	 <p><i>139 D2030.20-LOD-350 Stormwater Drainage Piping</i></p>

Reference Part II Attribute Tables for non-graphical information

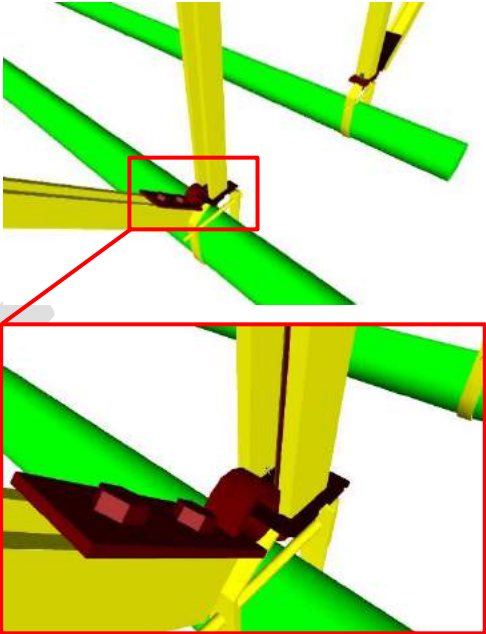
400	See D2030.10	 <p>140 D2030.20-LOD-400 Stormwater Drainage Piping</p>
-----	------------------------------	---





DRAFT

Reference Part II Attribute Tables for non-graphical information

D2030.30 21-04 20 30 30 Facility Stormwater Drains

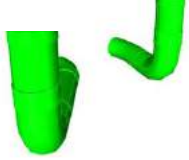
Includes: Various types of drains to collect storm water.

Associated Masterformat Sections: 22 14 26

100	See D20	
200	Schematic layout with approximate size, shape, and location of components;	 <p>141 D2030.30-LOD-200 Facility Stormwater Drains</p>
300	Modeled as design-specified size, shape, spacing, and location of components; approximate allowances for spacing and clearances required for all specified hangers, supports, vibration and seismic control that are to be utilized in the layout of all components; access/code clearance requirements modeled.	 <p>142 D2030.30-LOD-300 Facility Stormwater Drains</p>
350	Modeled as actual construction elements size, shape, spacing, and location/connections of components; actual size, shape, spacing, and clearances required for all hangers, supports, vibration and seismic control that are utilized in the layout of all components. Actual access/code clearance requirements modeled.	 <p>143 D2030.30-LOD-350 Facility Stormwater Drains</p>
400	See D2030.10	 <p>144 D2030.30-LOD-400 Facility Stormwater Drains</p>

Reference Part II Attribute Tables for non-graphical information

D2030.60 21-04 20 30 60 Gray Water Systems
Includes: Systems to collect, treat, and distribute gray water for other uses such as irrigation.

Associated Masterformat Sections: 22 13 63

[See [D2030.20](#)]

D2030.90 21-04 20 30 90 Building Support Plumbing System Supplementary

Components

Includes: Common work results for plumbing, plumbing insulation, and instrumentation and control for plumbing to be included with building support plumbing system elements above as appropriate. Includes expansion fittings, meters, gages, valves, hangers, supports, heat tracing, vibration and seismic controls.

These components are typically modeled as part of other assemblies listed in the tables above. Do not assign this Uniformat classification unless a supplementary component is modeled independently of another assembly.

Associated Masterformat Sections: 05 45 13 / 22 05 00 / 22 05 16 / 22 05 19 / 22 05 23
 22 05 29 / 22 05 33 / 22 05 48 / 22 05 53 / 22 07 00 / 22 09 00

D2050 21-04 20 50 General Service Compressed-Air
Includes: Compressed air system serving general service requirements

Associated Masterformat Sections: 01 86 16 / 22 15 00 / 22 15 13 / 22 15 16 / 22 15 19

[See [D2060.10](#) – Compressed-Air Systems]

D2060 21-04 20 60 Process Support Plumbing Systems
Includes: Process Support Plumbing System Supplementary Components as appropriate.

Associated Masterformat Sections:

100	See D20	
200	Schematic layout with approximate size, shape, and location of mains and risers; shaft requirements modeled;	

Reference Part II Attribute Tables for non-graphical information

D2060.10 21-04 20 60 10 Compressed-Air Systems

Associated Masterformat Sections: 01 86 16 / 22 61 00 / 22 61 13 / 22 61 19

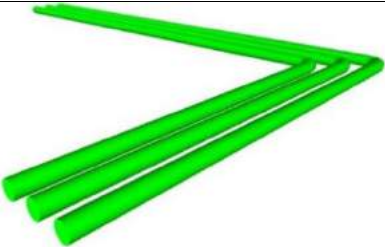
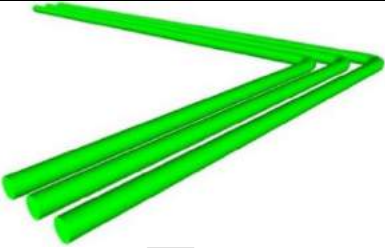
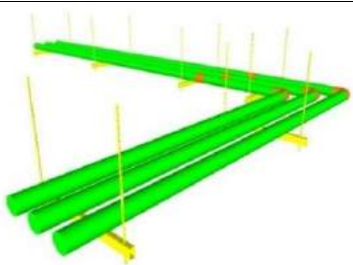
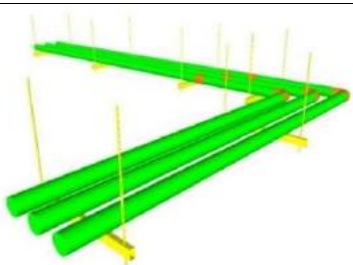
100	See D20	
200	See D2060	 <p>145D2060.10-LOD-200 Compressed-Air Systems</p>
300	<p>Modeled as design-specified size, shape, spacing, location, and slope of equipment/pipe, valves, fittings, and insulation for risers, mains, and branches;</p> <p>approximate allowances for spacing and clearances required for all specified hangers, supports, vibration and seismic control that are to be utilized in the layout of all risers, mains, and branches;</p> <p>access/code clearance requirements modeled.</p>	 <p>146D2060.10-LOD-300 Compressed-Air Systems</p>
350	<p>Modeled as actual size, shape, spacing, location, connections, and slope of equipment/pipe, valves, fittings, and insulation for risers, mains, and branches;</p> <p>actual size, shape, spacing, and clearances required for all hangers, supports, vibration and seismic control that are utilized in the layout of all risers, mains, and branches;</p> <p>actual access/code clearance requirements modeled.</p> <p>actual floor and wall penetrations modeled.</p>	 <p>147D2060.10-LOD-350 Compressed-Air Systems</p>
400	<p>Supplementary components added to the model required for fabrication and field installation.</p>	 <p>148D2060.10-LOD-400 Compressed-Air Systems</p>

Reference Part II Attribute Tables for non-graphical information**D2060.20 21-04 20 60 20 Vacuum Systems**

Includes: Vacuum systems for laboratory and healthcare purposes.

Associated Masterformat Sections: 01 86 16 / 22 62 00 / 22 62 13 / 22 62 19 / 22 62 23

[See [D2060.10](#)]

D2060.30 21-04 20 60 30 Gas Systems

Includes: Gas systems for laboratory and healthcare purposes.

Associated Masterformat Sections: 01 86 16 / 22 63 00 / 22 63 13 / 22 63 19

[See [D2060.10](#)]

D2060.40 21-04 20 60 40 Chemical-Waste Systems

Includes: Chemical-waste systems for laboratory and healthcare purposes.

Associated Masterformat Sections: 01 86 16 / 22 66 00 / 22 66 53 / 22 66 70 / 22 66 83

[See [D2060.10](#)]

D2060.50 21-04 20 60 50 Processed Water Systems

Includes: Processed water systems for laboratory and healthcare purposes.

Associated Masterformat Sections: 01 86 16 / 22 67 00 / 22 67 13 / 22 67 19

[See [D2060.10](#)]

D2060.90 21-04 20 60 90 Process Support Plumbing System Supplementary Components

Includes expansion fittings, meters, gages, valves, hangers, supports, heat tracing, vibration and seismic controls. Includes: Common work results for plumbing, plumbing insulation, and instrumentation and controls to be included with process support plumbing systems elements above as appropriate.

These components are typically modeled as part of other assemblies listed in the tables above. Do not assign this Uniformat classification unless a supplementary component is modeled independently of another assembly.

Associated Masterformat Sections: 05 45 13 / 05 45 23 / 22 05 00 / 22 05 23 / 22 05 29 / 22 05 33 / 22 05 48 / 22 05 53 / 22 07 00 / 22 09 00

Reference Part II Attribute Tables for non-graphical information

D30 21-04 30 Heating, Ventilation, and Air Conditioning (HVAC)

Associated Masterformat Sections: 01 86 19 / 23 00 00

100	Diagrammatic or schematic model elements; conceptual and/or schematic layout/flow diagram;	
-----	--	--

D3010 21-04 30 10 Facility Fuel Systems

Includes: Fuel-oil, gasoline, natural-gas, and liquefied-petroleum fuel systems associated with a structure.

Associated Masterformat Sections: 01 86 19 / 23 10 00

100	See D30	
200	Schematic layout with approximate size, shape, and location of element(s); approximate access/code clearance requirements modeled; shaft requirements modeled;	

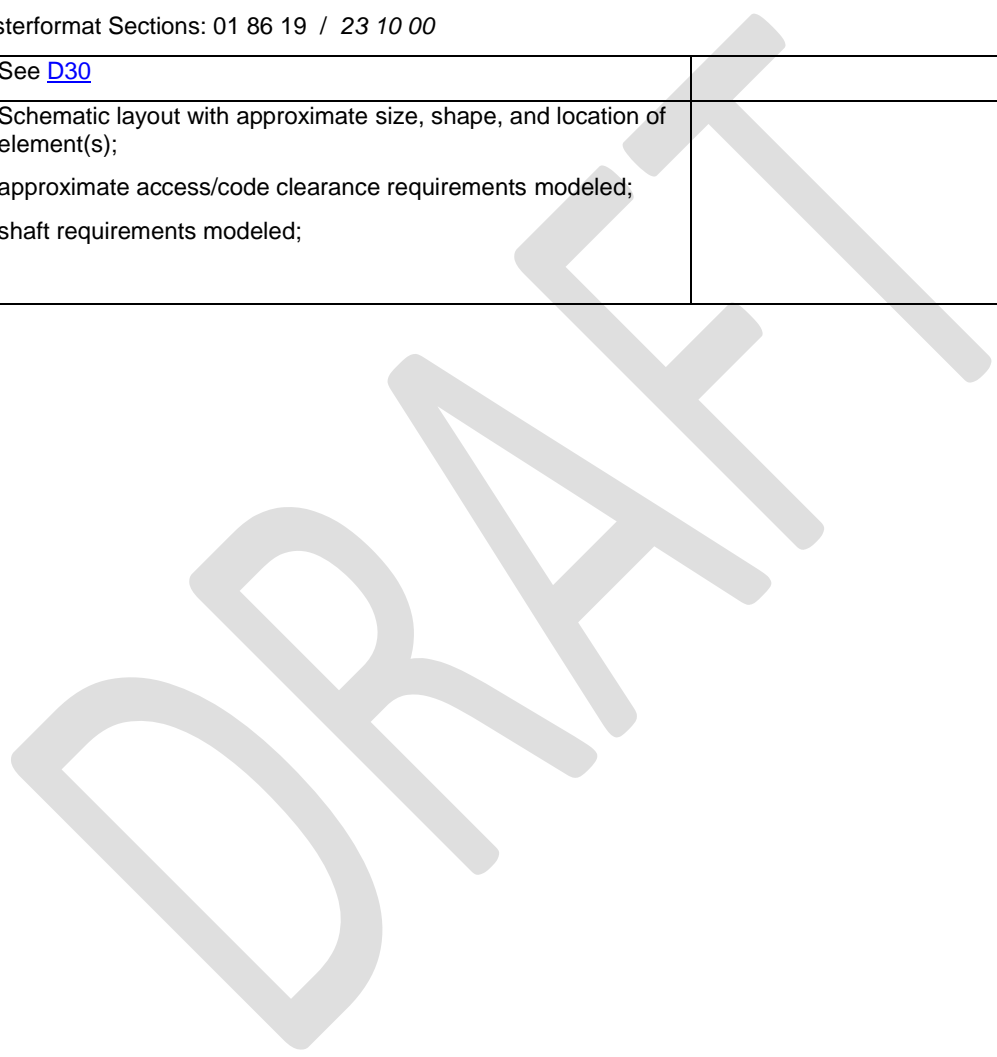

Reference Part II Attribute Tables for non-graphical information

D3010.10 21-04 30 10 10 Fuel Piping

Includes: Fuel piping, valves, piping specialties, and other components within, under, or closely associated with a structure.

Associated Masterformat Sections: 23 11 00

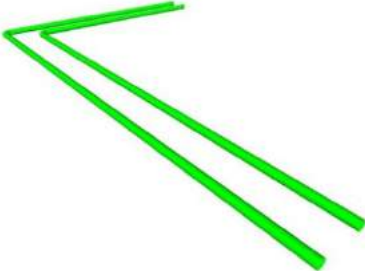
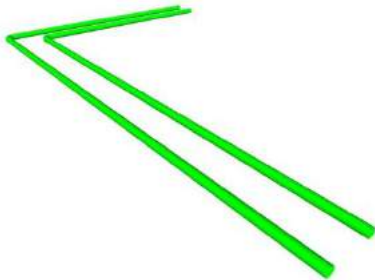
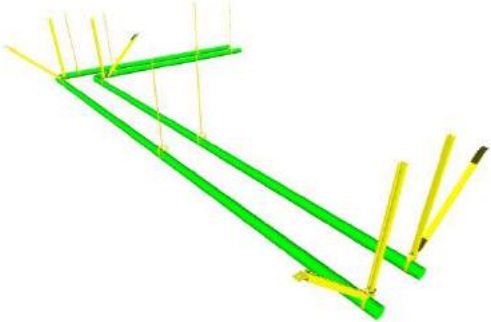
100	See D30	
200	See D3010	 <p>149 D3010.10-200 Fuel Piping</p>
300	<p>Modeled as design-specified size, shape, spacing, and location of pipe, valves, fittings, and insulation for risers, mains, and branches;</p> <p>approximate allowances for spacing and clearances required for all specified hangers, supports, vibration and seismic control that are to be utilized in the layout of all risers, mains, and branches;</p> <p>access/code clearance requirements modeled.</p>	 <p>150 D3010.10-300 Fuel Piping</p>
350	<p>Modeled as actual size, shape, spacing, and location/connections of pipe, valves, fittings, and insulation for risers, mains, and branches;</p> <p>actual size, shape, spacing, and clearances required for all hangers, supports, vibration and seismic control that are utilized in the layout of all risers, mains, and branches;</p> <p>actual access/code clearance requirements modeled.</p> <p>actual floor and wall penetrations modeled.</p>	 <p>151 D3010.10-350 Fuel Piping</p>

Reference Part II Attribute Tables for non-graphical information

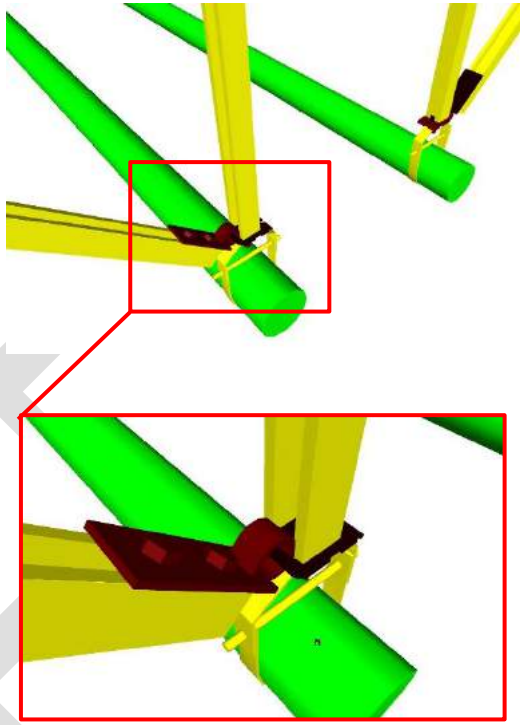
<p>400</p>	<p>Supplementary components added to the model required for fabrication and field installation</p>	 <p>152 D3010.10-400 Fuel Piping</p>
------------	--	--

D3010.30 21-04 30 10 30 Fuel Pumps

Includes: Fuel pumps within or closely associated with a structure.

Associated Masterformat Sections: 23 12 00 / 23 12 13 / 23 12 16

<p>100</p>	<p>See D30</p>	
<p>200</p>	<p>See D3010</p>	
<p>300</p>	<p>Modeled as design-specified size, shape, spacing, and location of equipment; approximate allowances for spacing and clearances required for all specified anchors, supports, vibration and seismic control that are utilized in the layout of equipment; access/code clearance requirements modeled.</p>	
<p>350</p>	<p>Modeled as actual size, shape, spacing, and location/connections of equipment; actual size, shape, spacing, and clearances required for all specified anchors, supports, vibration and seismic control that are utilized in the layout of equipment. actual access/code clearance requirements modeled.</p>	
<p>400</p>	<p>See D3010.10</p>	

Reference Part II Attribute Tables for non-graphical information

D3010.50 21-04 30 10 50 Fuel Storage Tanks

Includes: Fuel tanks under or closely associated with a structure.

Associated Masterformat Sections: 23 13 00

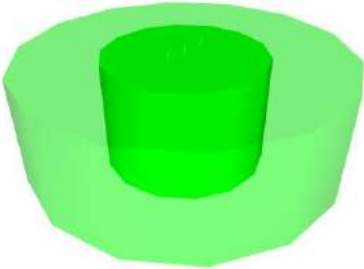
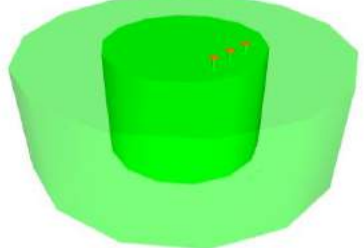
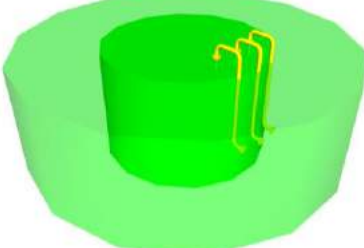
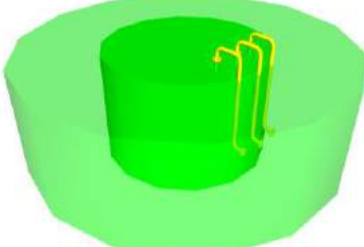
100	See D30	
200	See D3010	 <p>153 D3010.50-LOD-200 Fuel Storage Tanks</p>
300	<p>Modeled as design-specified size, shape, spacing, and location of tank(s);</p> <p>approximate allowances for spacing and clearances required for all specified anchors, supports, vibration and seismic control that are utilized in the layout of tanks(s);</p> <p>access/code clearance requirements modeled.</p>	 <p>154 D3010.50-LOD-300 Fuel Storage Tanks</p>
350	<p>Modeled as actual size, shape, spacing, and location/connections of tank(s);</p> <p>actual size, shape, spacing, and clearances required for all specified anchors, supports, vibration and seismic control that are utilized in the layout of tanks(s).</p> <p>actual access/code clearance requirements modeled.</p>	 <p>155 D3010.50-LOD-350 Fuel Storage Tanks</p>
400	See D3010.10	 <p>156 D3010.50-LOD-400 Fuel Storage Tanks</p>

3020 21-04 30 20 Heating Systems

Includes: Associated ductwork, piping, valves, and specialties. Includes: Heating System Supplementary Components as appropriate.

Associated Masterformat Sections: 01 86 19

Reference Part II Attribute Tables for non-graphical information

100	See D30	
200	Schematic layout with approximate size, shape, and location of element(s); shaft requirements modeled;	

DRAFT

Reference Part II Attribute Tables for non-graphical information

D3020.10 21-04 30 20 10 Heat Generation

Includes: Boilers, furnaces, solar, geothermal, and biomass heat generation, fuel fired heaters, and heat exchangers. Includes: Fuel-fired boilers and generators for hot water and steam systems. Includes breechings, chimneys, and stacks. Includes: Electric boilers and generators for hot water and steam systems. Includes: Equipment to remove oxygen and other dissolved gases in boiler feed. Includes: Fuel-fired and electric furnaces. Includes: Equipment powered by solar energy. Includes: Fuel-fired radiant and unit heaters. Includes: Equipment used to transfer heat from one medium to another.

Associated Masterformat Sections: 23 51 00 / 23 52 00 / 23 52 13 / 23 53 00 / 23 53 13 / 23 53 16 / 23 54 00 / 23 56 00 / 23 56 13 / 23 56 16 / 23 55 00 / 23 57 00

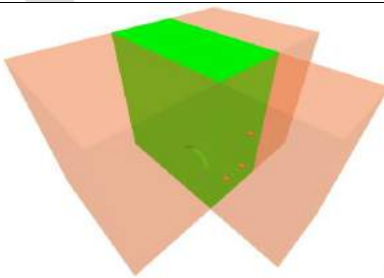
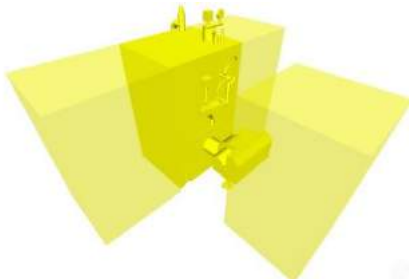
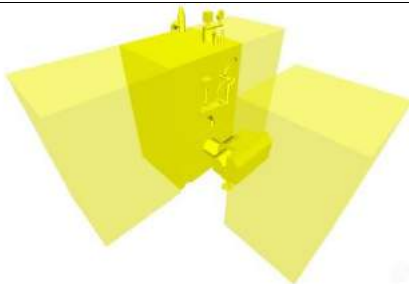
100	See D30	
200	See D3020	 <p>157D3020.10-LOD-200 Heat Generation</p>
300	<p>Modeled as design-specified size, shape, spacing, and location of equipment;</p> <p>approximate allowances for spacing and clearances required for all specified anchors, supports, vibration and seismic control that are utilized in the layout of equipment;</p> <p>access/code clearance requirements modeled.</p>	 <p>158D3020.10-LOD-300 Heat Generation</p>
350	<p>Modeled as actual size, shape, spacing, and location/connections of equipment,</p> <p>actual size, shape, spacing, and clearances required for all specified anchors, supports, vibration and seismic control that are utilized in the layout of equipment.</p> <p>actual access/code clearance requirements modeled.</p>	 <p>159D3020.10-LOD-350 Heat Generation</p>
400	<p>Supplementary components added to the model required for fabrication and field installation.</p>	 <p>160D3020.10-LOD-400 Heat Generation</p>

D3020.30 21-04 30 20 30 Thermal Heat Storage

Includes: Equipment to store thermal energy for use in heating and with charging or discharging this energy at a controllable rate.

Reference Part II Attribute Tables for non-graphical information

Associated Masterformat Sections: 23 71 13

[See [D3020.10](#)]

D3020.70 21-04 30 20 70 Decentralized Heating Equipment

Includes: Heating equipment that serves a portion of a HVAC system. Includes: Convection units may provide heating and cooling. Includes: Electric cables or panels and hydronic piping used for radiant heating for space heating.

Associated Masterformat Sections: 23 80 00 / 23 82 00 / 23 82 13 / 23 82 14 / 23 82 16 / 23 82 19 / 23 82 23 / 23 82 26 / 23 82 29 / 23 82 33 / 23 82 36 / 23 82 39 / 23 83 00

[See [D3020.10](#)]

D3020.90 21-04 30 20 90 Heating System Supplementary Components

Includes: Common work results for HVAC, insulation, and instrumentation and control to be included in heating system elements above as appropriate.

These components are typically modeled as part of other assemblies listed in the tables above. Do not assign this Uniformat classification unless a supplementary component is modeled independently of another assembly.

Associated Masterformat Sections: 05 45 13 / 23 05 00 / 23 05 19 / 23 05 23 / 23 05 29 / 23 05 48 / 23 05 53 / 23 05 63 / 23 05 66 / 23 05 93 / 23 07 00 / 23 09 00

D3030 21-04 30 30 Cooling Systems

Includes: Associated ductwork, piping, valves, and specialties. Includes: Cooling System Supplementary Components as appropriate.

Associated Masterformat Sections: 01 86 19

100	See D30	
200	Schematic layout with approximate size, shape, and location of element(s); shaft requirements modeled;	

Reference Part II Attribute Tables for non-graphical information

D3030.10 21-04 30 30 10 Central Cooling

Includes: Refrigerant compressors, condensers, packaged compressor and condenser units, water chillers, and cooling towers. Includes: Various type of compressors used in refrigeration process. Includes: Condensing units used to reject heat from the refrigeration process. Includes: Compressor in combination with condensing units used to reject heat from the refrigeration process. Includes: Various types of chillers used for building space cooling. Includes: Factory- and field-fabricated cooling towers and liquid coolers. Includes piping and specialties; chemical water treatment; vibration and seismic controls; and integral controls not a part of the condenser water distribution systems.

Associated Masterformat Sections: 23 60 00 / 23 61 00 / 23 62 00 / 23 63 00 / 23 64 00 / 23 65 00

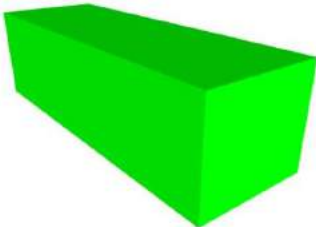
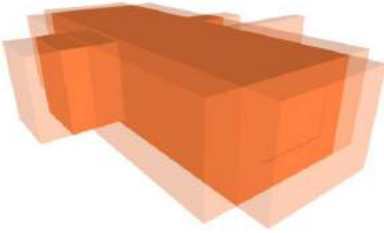
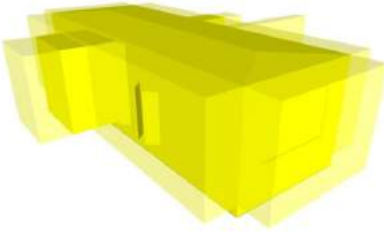
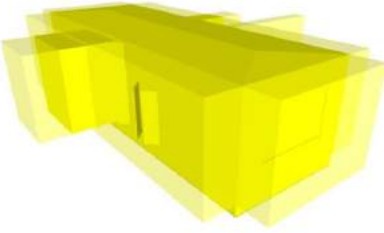
100	See D30	
200	See D3030	 <p>161 D3030.10-LOD-200 Central Cooling</p>
300	<p>Modeled as design-specified size, shape, spacing, and location of equipment;</p> <p>approximate allowances for spacing and clearances required for all specified anchors, supports, vibration and seismic control that are utilized in the layout of equipment;</p> <p>access/code clearance requirements modeled.</p>	 <p>162 D3030.10-LOD-300 Central Cooling</p>
350	<p>Modeled as actual size, shape, spacing, and location/connections of equipment;</p> <p>actual size, shape, spacing, and clearances required for all specified anchors, supports, vibration and seismic control that are utilized in the layout of equipment.</p> <p>actual access/code clearance requirements modeled.</p>	 <p>163 D3030.10-LOD-350 Central Cooling</p>
400	<p>Supplementary components added to the model required for fabrication and field installation.</p>	 <p>164 D3030.10-LOD-400 Central Cooling</p>

Reference Part II Attribute Tables for non-graphical information

D3030.30 21-04 30 30 30 Evaporative Air-Cooling

Includes: Equipment used to reject heat from the refrigeration process by evaporation.

Associated Masterformat Sections: 23 76 00

100	See D3030.10	
200	See D3030.10	 <p>165D3030.30-LOD-200 Evaporative Air-Cooling</p>
300	See D3030.10	 <p>166D3030.30-LOD-300 Evaporative Air-Cooling</p>
350	See D3030.10	 <p>167D3030.30-LOD-350 Evaporative Air-Cooling</p>
400	See D3030.10	 <p>168D3030.30-LOD-400 Evaporative Air-Cooling</p>

D3030.50 21-04 30 30 50 Thermal Cooling Storage

Includes: Equipment to store thermal energy for use in cooling and with charging or discharging this energy at a controllable rate.

Reference Part II Attribute Tables for non-graphical information

Associated Masterformat Sections: 23 71 00 / 23 71 16 / 23 71 19

[See [D3030.10](#)]

D3030.70 21-04 30 30 70 Decentralized Cooling

Includes: Cooling equipment that serves a portion of a HVAC system. Note: Convection units may provide heating and cooling.

Associated Masterformat Sections: 23 80 00 / 23 81 13 / 23 81 16 / 23 81 19 / 23 81 23 / 23 81 26 / 23 81 43 / 23 81 46 / 23 82 00 / 23 82 13 / 23 82 14 / 23 82 16 / 23 82 19 / 23 82 23 / 23 82 26

[See [D3030.10](#)]

D3030.90 21-04 30 30 90 Cooling System Supplementary Components

Includes expansion fittings, meters, gages, valves, hangers, supports, heat tracing, vibration and seismic controls. Includes: Common work results for HVAC, insulation, and instrumentation and control to be included in cooling system elements above as appropriate.

These components are typically modeled as part of other assemblies listed in the tables above. Do not assign this Uniformat classification unless a supplementary component is modeled independently of another assembly.

Associated Masterformat Sections: 05 45 13 / 23 05 00 / 23 05 19 / 23 05 23 / 23 05 29 / 23 05 48 / 23 05 53 / 23 05 63 / 23 05 66 / 23 05 93 / 23 07 00 / 23 09 00

D3050 21-04 30 50 Facility HVAC Distribution Systems

Includes: Facility Distribution Systems Supplementary Components as appropriate.

Associated Masterformat Sections:



100	See D30	
200	Schematic layout with approximate size, shape, and location of element(s);	

Reference Part II Attribute Tables for non-graphical information

D3050.10 21-04 30 50 10 Facility Hydronic Distribution

Includes: Piping systems and equipment for distribution of heating hot water and cooling chilled water. Includes piping systems, pumps, tanks, supports and anchors, vibration and seismic controls, identification, and piping and equipment insulation.

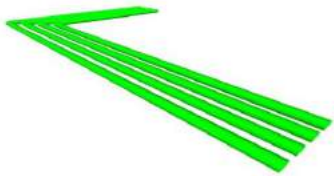
Associated Masterformat Sections: 01 86 19 / 23 21 13 / 23 21 23 / 23 25 00

100	See D30	
200	See D3050	 <p><i>169 D3050.10-LOD-200 Facility Hydronic distribution</i></p>
300	<p>Modeled as design-specified size, shape, spacing, location, and slope of pipe, valves, fittings, and insulation for risers, mains, and branches;</p> <p>approximate allowances for spacing and clearances required for all specified hangers, supports, vibration and seismic control that are to be utilized in the layout of all risers, mains, and branches;</p> <p>access/code clearance requirements modeled.</p>	 <p><i>170 D3050.10-LOD-300 Facility Hydronic Distribution</i></p>
350	<p>Modeled as actual size, shape, spacing, location, connections, and slope of pipe, valves, fittings, and insulation for risers, mains, and branches;</p> <p>actual size, shape, spacing, and clearances required for all hangers, supports, vibration and seismic control that are utilized in the layout of all risers, mains, and branches;</p> <p>actual floor and wall penetrations modeled.</p> <p>actual access/code clearance requirements modeled.</p>	 <p><i>171 D3050.10-LOD-350 Facility Hydronic Distribution</i></p>

Reference Part II Attribute Tables for non-graphical information

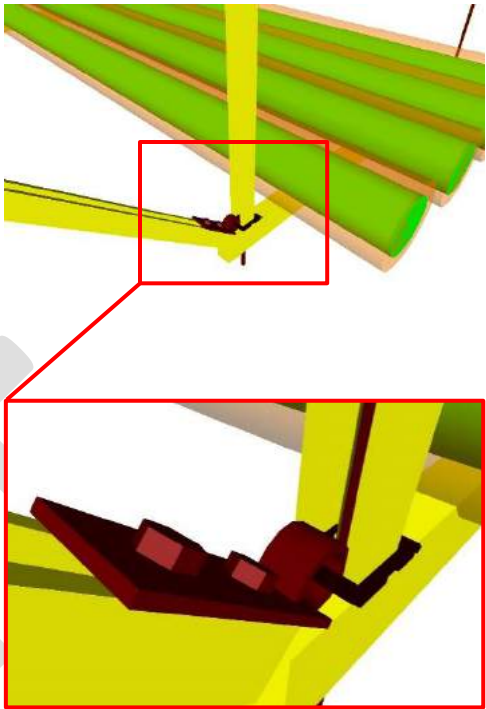
400	Supplementary components added to the model required for fabrication and field installation.	 <p>172 D3050.10-LOD-400 Facility Hydronic Distribution</p>
-----	--	--

D3050.30 21-04 30 50 30 Facility Steam Distribution

Includes: Piping systems and equipment for distribution of steam and condensate return. Includes piping systems, pumps, tanks, supports and anchors, vibration and seismic controls, identification, and piping and equipment insulation.

Associated Masterformat Sections: 01 86 19 / 23 22 13 / 23 22 23 / 23 25 19

[See [D3050.10](#)]

Reference Part II Attribute Tables for non-graphical information

D3050.50 21-04 30 50 50 HVAC Air Distribution

Includes: Systems for distribution of air including supply systems, return systems, and general exhaust systems. Does not include special exhaust systems such as kitchen hood, paint booth, and fume hood exhaust systems. Includes: Air-handling units consisting of fans, coils, dampers, control devices, and other accessories. Includes: Ducts, duct accessories, fans, terminal units, and air inlets and outlets. Includes: Devices of a variety of types to clean distribution air. Includes: Equipment that adds or removes moisture from a medium in order to control the humidity.

Associated Masterformat Sections: 01 86 19 / 23 73 00 / 23 74 00 / 23 75 00 / 23 30 00 / 23 34 00 / 23 31 00 / 23 32 00 / 23 33 00 / 23 36 00 / 23 37 00 / 23 40 00 / 23 41 00 / 23 42 00 / 23 43 00 / 23 84 00

100	See D30	
200	See D3050	
300	Modeled as design-specified size, shape, spacing, and location of duct, dampers, fittings, and insulation for risers, mains, and branches; approximate allowances for spacing and clearances required for all specified hangers, supports, vibration and seismic control that are to be utilized in the layout of all risers, mains, and branches; access/code clearance requirements modeled.	
350	Modeled as actual size, shape, spacing, and location/connections of duct, dampers, fittings, and insulation for risers, mains, and branches; actual size, shape, spacing, and clearances required for all hangers, supports, vibration and seismic control that are utilized in the layout of all risers, mains, and branches; actual floor and wall penetrations modeled. actual access/code clearance requirements modeled.	
400	See D3050.10	

D3050.90 21-04 30 50 90 Facility Distribution Systems Supplementary Components

Includes expansion fittings, meters, gages, valves, hangers, supports, heat tracing, vibration and seismic controls. Includes: Common work results for HVAC, insulation, and instrumentation and control to be included in distribution system elements above as appropriate.

These components are typically modeled as part of other assemblies listed in the tables above. Do not assign this Uniformat classification unless a supplementary component is modeled independently of another assembly.

Associated Masterformat Sections: 05 45 13 / 23 05 00 / 23 05 16 / 23 05 19 / 23 05 23 / 23 05 29 / 23 05 33 / 23 05 48 / 23 05 53 / 23 05 63 / 23 05 66 / 23 05 93 / 23 07 00 / 23 09 00

Reference Part II Attribute Tables for non-graphical information

D3060 21-04 30 60 Ventilation

Includes: Supply air, return air, exhaust air, outside air, and air cleaning systems. Includes Ventilation Supplementary Components as appropriate.

Associated Masterformat Sections: 01 86 19

100	See D30	
200	Schematic layout with approximate size, shape, and location of mains and risers;	

D3060.10 21-04 30 60 10 Supply Air

Associated Masterformat Sections: 23 34 00 / 23 31 00 / 23 32 00 / 23 33 00 / 23 36 00 / 23 37 00

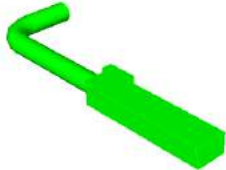
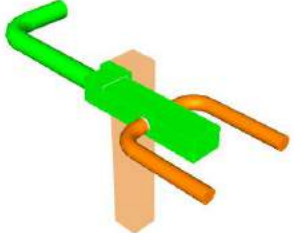
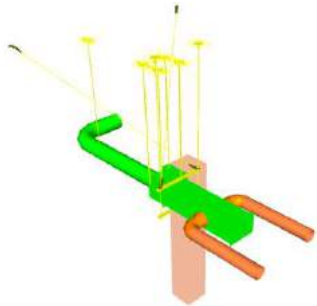
100	See D30	
200	See D3060	 <p><i>173D3060.10-LOD-200 Supply Air</i></p>
300	<p>Modeled as design-specified size, shape, spacing, and location of duct, dampers, fittings, and insulation for risers, mains, and branches;</p> <p>approximate specified allowances for spacing and clearances required for all hangers, supports, vibration and seismic control that are to be utilized in the layout of all risers, mains, and branches;</p> <p>access/code clearance requirements modeled.</p>	 <p><i>174D3060.10-LOD-300 Supply Air</i></p>
350	<p>Modeled as actual size, shape, spacing, and location/connections of duct, dampers, fittings, and insulation for risers, mains, and branches;</p> <p>actual size, shape, spacing, and clearances required for all hangers, supports, vibration and seismic control that are utilized in the layout of all risers, mains, and branches;</p> <p>actual floor and wall penetrations modeled.</p> <p>actual access/code clearance requirements modeled.</p>	 <p><i>175D3060.10-LOD-350 Supply Air</i></p>

Reference Part II Attribute Tables for non-graphical information

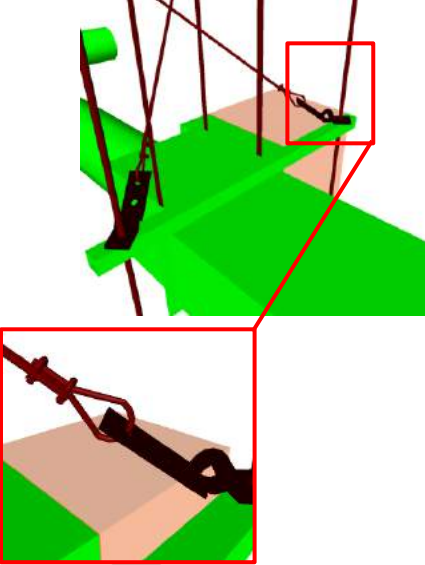
400	Supplementary components added to the model required for fabrication and field installation.	 <p>176D3060.10-LOD-400 Supply Air</p>
-----	--	--

D3060.20

21-04 30 60 20

Return Air

Associated Masterformat Sections: 23 34 00 / 23 31 00 / 23 32 00 / 23 33 00 / 23 37 00



[See [D3060.10](#)]

Reference Part II Attribute Tables for non-graphical information

D3060.30 21-04 30 60 30 Exhaust Air

Includes: Special systems for exhausting air such as kitchen hood, paint booth, and fume hood exhaust systems.

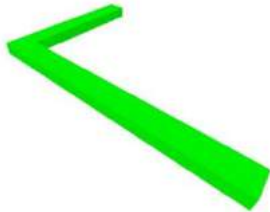
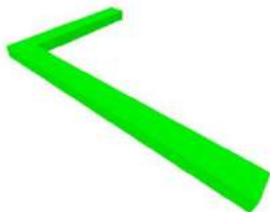
Associated Masterformat Sections: 23 35 00 / 23 35 13.13 / 23 35 16 / 23 38 00 / 23 38 13 / 23 38 16 / 23 34 00 / 23 31 00 / 23 32 00 / 23 33 00 / 23 37 00

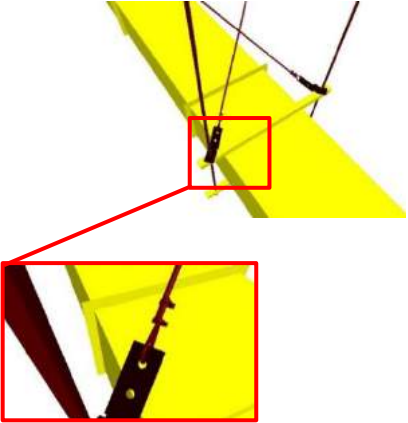
100	See D30	
200	See D3060	 <p>177 D3060.30-LOD-200 Exhaust Air</p>
300	<p>Modeled as design-specified size, shape, spacing, location, duct slope (if required), dampers, fittings, insulation for risers, mains, and branches; approximate specified allowances for spacing and clearances required for all hangers, supports, vibration and seismic control that are to be utilized in the layout of all risers, mains, and branches; access/code clearance requirements modeled.</p>	 <p>178 D3060.30-LOD-300 Exhaust Air</p>
350	<p>Modeled as actual size, shape, spacing, location, and slope(if required)/connections of duct, dampers, fittings, and insulation for risers, mains, and branches; actual size, shape, spacing, and clearances required for all hangers, supports, vibration and seismic control that are utilized in the layout of all risers, mains, and branches; actual floor and wall penetration elements modeled. actual access/code clearance requirements modeled.</p>	 <p>179 D3060.30-LOD-350 Exhaust Air</p>
400	See D3060.10	 <p>180 D3060.30-LOD-400 Exhaust Air</p>

D3060.40 21-04 30 60 40 Outside Air

Associated Masterformat Sections: 23 34 00 / 23 31 00 / 23 32 00 / 23 33 00 / 23 36 00 / 23 37 00

Reference Part II Attribute Tables for non-graphical information

[See [D3060.10](#)]

D3060.60 21-04 30 60 60 Air-to-Air Energy Recovery

Includes: Air-to-air energy recovery units.

Associated Masterformat Sections: 23 72 00

[See [D3060.10](#)]

D3060.70 21-04 30 60 70 HVAC Air Cleaning

Associated Masterformat Sections: 23 40 00

[See [D3060.10](#)]

D3060.90 21-04 30 60 90 Ventilation Supplementary Components

Includes expansion fittings, meters, gages, valves, hangers, supports, heat tracing, vibration and seismic controls. Includes: Common work results for HVAC, insulation, and instrumentation and control to be included in ventilation elements above as appropriate.

These components are typically modeled as part of other assemblies listed in the tables above. Do not assign this Uniformat classification unless a supplementary component is modeled independently of another assembly.

Associated Masterformat Sections: 05 45 13 / 23 05 00 / 23 05 29 / 23 05 48 / 23 05 53 / 23 05 63 / 23 05 66 / 23 05 93 / 23 07 00 / 23 09 00

D3070 21-04 30 70 Special Purpose HVAC Systems

Associated Masterformat Sections:

100	See D30	
200	Schematic layout with approximate size, shape, and location of components;	

D3070.10 21-04 30 70 10 Snow Melting

Includes: Electric cables and hydronic piping used for snow and ice control.

Associated Masterformat Sections: 23 83 13 / 23 83 16

100	See D30	
200	See D3070	
300	Modeled as design-specified size, shape, spacing, and location of supplementary components; approximate allowances for spacing and clearances required for all specified hangers, supports, vibration and seismic control that are to be utilized in the layout of all supplementary components; access/code clearance requirements modeled.	

Reference Part II Attribute Tables for non-graphical information

350	Modeled as actual size, shape, spacing, and location/connections of supplementary components; actual size, shape, spacing, and clearances required for all hangers, supports, vibration and seismic control that are utilized in the layout of all supplementary components. actual access/code clearance requirements modeled.	
400	Supplementary components added to the model required for fabrication and field installation.	

D40**21-04 40****Fire Protection**

Associated Masterformat Sections:

100	Diagrammatic or schematic model elements; conceptual and/or schematic layout/flow diagram;	
-----	---	--

D4010**21-04 40 10****Fire Suppression***Includes: Fire Suppression Supplementary Components as appropriate.*

Associated Masterformat Sections: 01 86 13 / 21 00 00



100	See D40	
200	Schematic layout with approximate size, shape, and location of mains and risers;	

Reference Part II Attribute Tables for non-graphical information

D4010.10 21-04 40 10 10 Water-Based Fire-Suppression

Includes: Systems that use water for fire extinguishing and suppression. Includes piping, fittings, and specialties; hoses, valves, cabinets; fire pumps, accessories, and controls. Includes: Piping, fittings, valves, hangers, supports, other specialties, and sprinklers for fire protection systems. Includes limited area sprinkler systems, fire pumps, accessories, and controls.

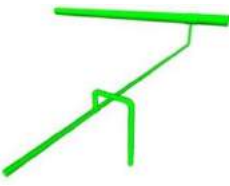
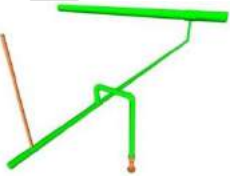
Associated Masterformat Sections: 01 86 13 / 21 10 00 / 21 11 00 / 21 12 00 / 21 13 00 / 21 13 13 / 21 13 16 / 21 13 19 / 21 13 23 / 21 13 26 / 21 13 29 / 21 13 36 / 21 13 39 / 21 30 00 / 21 40 00

100	See D40	
200	See D4010	 <p><i>181 D4010.10-LOD-200 Water-Based Fire-Suppression</i></p>
300	<p>Modeled as design-specified size, shape, spacing, and location of pipe/slope(if required)/valves/fittings/insulation for risers, mains, and branches/standpipes;</p> <p>approximate allowances for spacing and clearances required for all specified hangers, supports, vibration and seismic control that are to be utilized in the layout of all risers, mains, and branches/standpipes;</p> <p>access/code clearance requirements modeled.</p>	 <p><i>182 D4010.10-LOD-300 Water-Based Fire-Suppression</i></p>
350	<p>Modeled as actual size, shape, spacing, and location/ slope(if required)/connections of pipe, valves, fittings, and insulation for risers, mains, and branches/standpipes;</p> <p>actual size, shape, spacing, and clearances required for all hangers, supports, vibration and seismic control that are utilized in the layout of all risers, mains, and branches/standpipes;</p> <p>actual floor and wall penetration elements modeled.</p> <p>actual access/code clearance requirements modeled.</p>	 <p><i>183 D4010.10-LOD-350 Water-Based Fire-Suppression</i></p>
400	Supplementary components added to the model required for fabrication and field installation.	 <p><i>184 D4010.10-LOD-400 Water-Based Fire-Suppression</i></p>

Reference Part II Attribute Tables for non-graphical information

D4010.50 21-04 40 10 50 Fire-Extinguishing

Includes: Systems that use other than water for fire extinguishing and suppression. Includes piping, fittings, and specialties; valves, accessories, and controls.

Associated Masterformat Sections: 21 20 00 / 21 21 00 / 21 22 00 / 21 23 00 / 21 24 00

[See [D4010.10](#)]

DRAFT

Reference Part II Attribute Tables for non-graphical information

D4010.90 21-04 40 10 90 Fire Suppression Supplementary Components

Includes: Expansion fittings and loops, meters and gages, general-duty valves, hanger and supports, heat tracing, vibration and seismic controls, identification, insulation, and instrumentation and control to be included in fire protection elements above as appropriate.

These components are typically modeled as part of other assemblies listed in the tables above. Do not assign this Uniformat classification unless a supplementary component is modeled independently of another assembly.

Associated Masterformat Sections: 05 45 13 / 21 05 00 / 21 05 16 / 21 05 19 / 21 05 23 / 21 05 29 / 21 05 33 / 21 05 48 / 21 05 53 / 21 07 00 / 21 09 00

D4030 21-04 40 30 Fire Protection Specialties

Includes: Firefighting devices and storage cabinets except devices connected to a fire suppression system.

Associated Masterformat Sections: 10 44 00

100	See D40	
200	Schematic layout with approximate size, shape, and location of components;	

D4030.10 21-04 40 30 10 Fire Protection Cabinets

Associated Masterformat Sections: 10 44 13

100	See D40	
200	See D4030	
300	Modeled as design-specified size, shape, spacing, and location of components; approximate allowances for spacing and clearances required for all specified hangers, supports, vibration and seismic control that are to be utilized in the layout of all components; access/code clearance requirements modeled.	
350	Modeled as actual size, shape, spacing, and location/connections of components; actual size, shape, spacing, and clearances required for all hangers, supports, vibration and seismic control that are utilized in the layout of all components. actual access/code clearance requirements modeled.	
400	Supplementary components added to the model required for fabrication and field installation.	

D4030.30 21-04 40 30 30 Fire Extinguishers

Associated Masterformat Sections: 10 44 16

[See [D4030.10](#)]

D4030.50 21-04 40 30 50 Breathing Air Replenishment Systems

Associated Masterformat Sections: 10 44 33

[See [D4030.10](#)]

D4030.70 21-04 40 30 70 Fire Extinguisher Accessories

Associated Masterformat Sections: 10 44 43

[See [D4030.10](#)]

Reference Part II Attribute Tables for non-graphical information

D50 21-04 50 Electrical

Associated Masterformat Sections: 26 00 00 / 01 86 26

100	Diagrammatic or schematic model elements: conceptual and/or schematic layout;	
-----	--	--

D5010 21-04 50 10 Facility Power Generation

Includes: Power Generation Supplementary Components as appropriate.

Associated Masterformat Sections: 01 86 26

100	See D50	
200	Schematic layout with approximate size, shape, and location of equipment;	

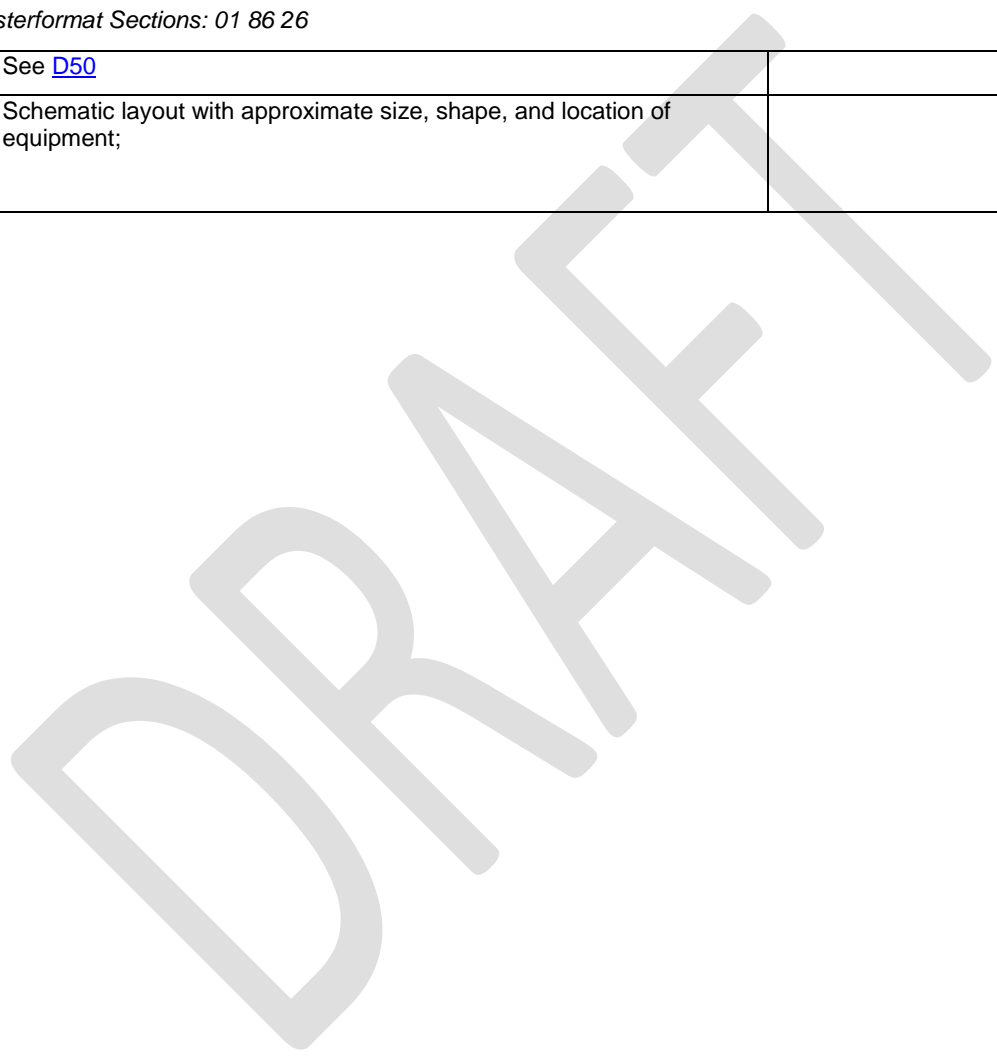

Reference Part II Attribute Tables for non-graphical information

D5010.10 21-04 50 10 10 Packaged Generator Assemblies

Includes: Generator, frequency changers, and rotary converters and uninterruptible power units.

Associated Masterformat Sections: 26 32 00 / 26 32 13 / 26 32 16 / 26 32 19 / 26 32 23 / 26 32 26 / 26 32 29 / 26 32 33

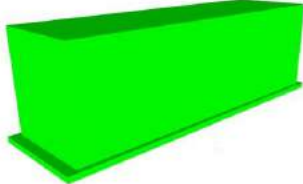
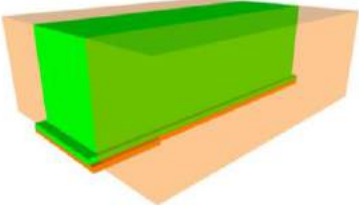
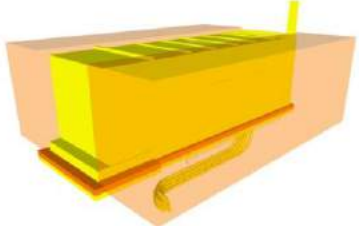
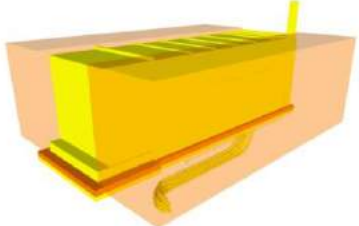
100	See D50	
200	See D5010	 <p><i>185 D5010.10-LOD-200 Packaged Generator Assemblies</i></p>
300	Modeled as design-specified size, shape, spacing, and location of equipment and associated components; approximate allowances for spacing and clearances required for all specified supports and seismic control; access/code clearance requirements modeled.	 <p><i>186 D5010.10-LOD-300 Packaged Generator Assemblies</i></p>
350	Modeled as actual size, shape, spacing, and location of equipment and associated components; actual size, shape, spacing, and location for supports and seismic control; actual size, shape, and location/connections of equipment and support structure/pads. actual access/code clearance requirements modeled.	 <p><i>187 D5010.10-LOD-350 Packaged Generator Assemblies</i></p>
400	Supplementary components added to the model required for fabrication and field installation.	 <p><i>188 D5010.10-LOD-400 Packaged Generator Assemblies</i></p>

Reference Part II Attribute Tables for non-graphical information**D5010.20 21-04 50 10 20 Battery Equipment***Includes: Batteries, battery racks, battery chargers, static power converters, uninterruptible power supplies, and accessories.**Associated Masterformat Sections: 26 33 00 / 26 33 13 / 26 33 16 / 26 33 19 / 26 33 23 / 26 33 33 / 26 33 43 / 26 33 46 / 26 33 53*[See [D5010.10](#)]**D5010.30 21-04 50 10 30 Photovoltaic Collectors***Includes: Solar cells to convert sunlight to electricity.**Associated Masterformat Sections: 26 31 00*[See [D5010.10](#)]**D5010.40 21-04 50 10 40 Fuel Cells***Includes: Fuel cell electricity generating equipment.**Associated Masterformat Sections: 48 18 00*[See [D5010.10](#)]**D5010.70 21-04 50 10 70 Transfer Switches***Includes: Switches that transfer from one source of electricity to another.**Associated Masterformat Sections: 26 36 00*[See [D5010.10](#)]**D5020 21-04 50 20 Electrical Service and Distribution***Includes: Electrical Service and Distribution Supplementary Components as appropriate.**Associated Masterformat Sections: 01 86 26*

100	See D50	
200	Schematic layout with approximate size, shape, and location of equipment;	

Reference Part II Attribute Tables for non-graphical information

D5020.10 21-04 50 20 10 Electrical Service Entrance

Includes: Meters, substations, transformers, switchgear, switchboards, and protective devices where electrical power enters structure.

Associated Masterformat Sections: 26 21 00 / 26 16 00 / 26 11 00 / 26 12 00 / 26 22 00 / 26 13 00 / 22 23 00 / 26 18 00 / 22 28 00

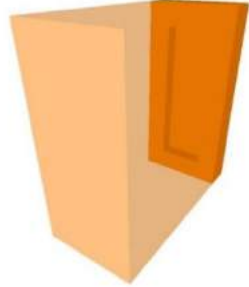
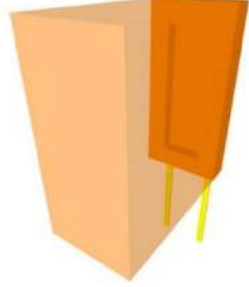
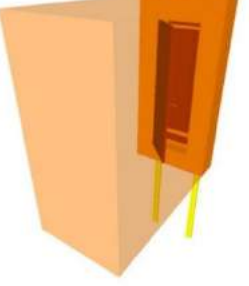
100	See D50	
200	See D5020	
300	<p>Modeled as design-specified size, shape, spacing, and location of equipment and associated components;</p> <p>approximate allowances for spacing and clearances required for all specified supports and seismic control;</p> <p>access/code clearance requirements modeled.</p>	 <p><i>189 D5020.10-LOD-300 Electrical Service Entrance</i></p>
350	<p>Modeled as actual size, shape, spacing, and location of equipment and associated components;</p> <p>actual size, shape, spacing, and location for supports and seismic control;</p> <p>actual size, shape, and location/connections of equipment and support structure/pads.</p> <p>actual access/code clearance requirements modeled.</p>	 <p><i>190 D5020.10-LOD-350 Electrical Service Entrance</i></p>
400	<p>Supplementary components added to the model required for fabrication and field installation.</p>	 <p><i>191 D5020.10-LOD-400 Electrical Service Entrance</i></p>

Reference Part II Attribute Tables for non-graphical information

D5020.30 21-04 50 20 30 Power Distribution

Includes: Bus assemblies, distribution equipment, and electrical wiring system to distribute electrical power to switchboards, panelboards, and motor control centers.

Associated Masterformat Sections: 26 20 00 / 26 24 00 / 26 24 13 / 26 24 16 / 26 24 19 / 26 25 00 / 26 27 00 / 26 27 16 / 26 05 33 / 26 05 43 / 26 05 36 / 26 05 13

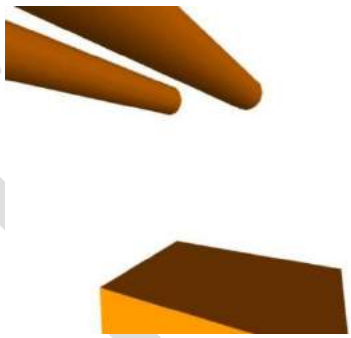
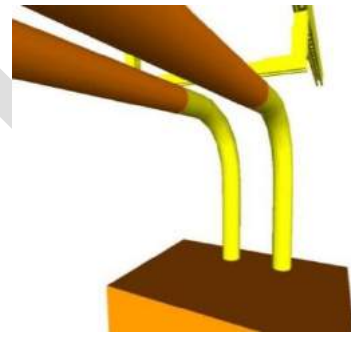
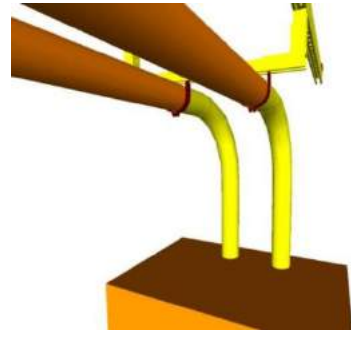
100	See D50	
200	See D5020	
300	<p>Modeled as design-specified size, shape, spacing, and location of raceways, boxes, enclosures, and equipment;</p> <p>approximate allowances for spacing and clearances required for all specified hangers, supports and seismic control;</p> <p>access/code clearance requirements modeled.</p>	 <p><i>192 D5020.30-LOD-300 Power Distribution</i></p>
350	<p>Modeled as actual size, shape, spacing, and location of raceways, boxes, and enclosures;</p> <p>actual size, shape, spacing, and location for supports and seismic control;</p> <p>actual size, shape, and location/connections of equipment and support structure/pads;</p> <p>actual floor and wall penetration elements are modeled.</p> <p>actual access/code clearance requirements modeled.</p>	 <p><i>193 D5020.30-LOD-350 Power Distribution</i></p>
400	<p>Supplementary components added to the model required for fabrication and field installation.</p>	 <p><i>194 D5020.30-LOD-400 Power Distribution</i></p>

D5020.70 21-04 50 20 70 Facility Grounding

Includes: Raceways, wiring and devices for grounding and bonding an electrical distribution system.

Reference Part II Attribute Tables for non-graphical information

Associated Masterformat Sections: 26 05 26 / 26 05 33 / 26 05 13

100	See D50	
200	See D5020	
300	Modeled as design-specified size, shape, spacing, and location of raceways, boxes, enclosures, and the electrical equipment and end-devices served; approximate allowances for spacing and clearances required for all specified hangers, supports, and seismic control; access/code clearance requirements modeled.	
350	Modeled as actual size, shape, spacing, and location of raceways, boxes, enclosures, and the electrical equipment and end-devices served; actual size, shape, spacing, and location for supports and seismic control; actual floor and wall penetration elements are modeled. actual access/code clearance requirements modeled.	
400	Supplementary components added to the model required for fabrication and field installation.	

D5030

21-04 50 30

General Purpose Electrical Power

Includes: General Purpose Electrical Power Supplementary Components as appropriate.

Associated Masterformat Sections: 01 86 26

100	See D50	
200	Schematic layout with approximate size, shape, and location of equipment;	

Reference Part II Attribute Tables for non-graphical information

D5030.10 21-04 50 30 10 Branch Wiring System

Includes: Raceways, ducts, cable trays, and wiring to deliver power from branch panelboards to the point of use.

Associated Masterformat Sections: 26 05 33 / 26 05 43 / 26 05 36 / 26 05 19

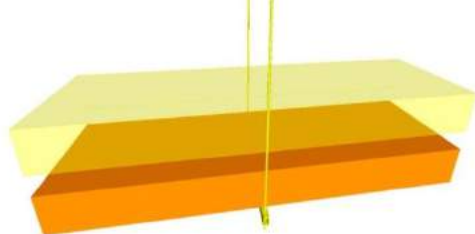
100	See D50	
200	See D5030	
300	Modeled as design-specified size, shape, spacing, and location of raceways, boxes, and enclosures; approximate allowances for spacing and clearances required for all specified hangers, supports and seismic control; access/code clearance requirements modeled.	 <p>195 D5030.10-LOD-300 Branch Wiring System</p>
350	Modeled as actual size, shape, spacing, and location of raceways, boxes, enclosures; actual size, shape, spacing, and location for supports and seismic control; actual floor and wall penetration elements are modeled. actual access/code clearance requirements modeled.	 <p>196 D5030.10-LOD-350 Branch Wiring System</p>
400	Supplementary components added to the model required for fabrication and field installation.	

D5030.50 21-04 50 30 50 Wiring Devices

Includes: Electrical devices at point of use including electrical outlets and switches.

Associated Masterformat Sections: 26 27 26

100	See D50	
200	See D5030	
300	Modeled as design-specified size, shape, spacing, and location of outlet boxes and devices; access/code clearance requirements modeled.	
350	Modeled as actual size, shape, spacing, and location of outlet boxes and devices. actual access/code clearance requirements modeled.	
400	Supplementary components added to the model required for fabrication and field installation.	

Reference Part II Attribute Tables for non-graphical information**D5040 21-04 50 40 Lighting***Includes: Lighting Supplementary Components as appropriate.*

Associated Masterformat Sections: 26 50 00 / 01 86 26

100	See D50	
200	Schematic layout with approximate size, shape, and location of equipment;	

D5040.10 21-04 50 40 10 Lighting Control*Includes: Clock and calendar, photoelectric switches, occupancy sensors, and light-leveling control devices.*

Associated Masterformat Sections: 26 09 23 / 26 09 26 / 26 09 33 / 26 09 36 / 26 09 43 / 26 09 61

100	See D50	
200	See D5040	
300	Modeled as design-specified size, shape, spacing, and location of enclosures, equipment, and devices; access/code clearance requirements modeled.	
350	Modeled as actual size, shape, spacing, and location of enclosures, equipment, and control devices; actual size, shape, and location/connections of equipment and control devices. actual access/code clearance requirements modeled.	
400	Supplementary components added to the model required for fabrication and field installation.	

Reference Part II Attribute Tables for non-graphical information

D5040.20 21-04 50 40 20 Branch Wiring for Lighting

Includes: Raceways, ducts, cable trays, and wiring beyond branch circuit panelboards to lighting fixtures.



Associated Masterformat Sections: 26 05 33 / 26 05 43 / 26 05 36 / 26 05 19 / 26 27 26

100	See D50	
200	See D5040	
300	Modeled as design-specified size, shape, spacing, and location of raceways, boxes, and enclosures to fixture locations; approximate allowances for spacing and clearances required for all specified hangers, supports, and seismic control. access/code clearance requirements modeled.	
350	Modeled as actual size, shape, spacing, and location of raceways, boxes, and enclosures to fixture locations; actual size, shape, spacing, and location for supports and seismic control; actual floor and wall penetration elements are modeled. actual access/code clearance requirements modeled.	
400	Supplementary components added to the model required for fabrication and field installation.	

D5040.50 21-04 50 40 50 Lighting Fixtures

Includes: Luminaires, lighting equipment, ballasts, and accessories. Includes fluorescent, high intensity discharge, incandescent, mercury vapor, neon, and sodium vapor lighting.

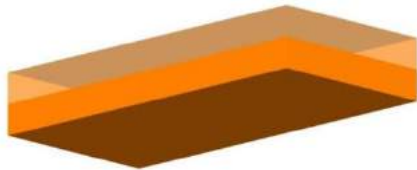
Associated Masterformat Sections: 26 50 00 / 26 51 00 / 26 52 00 / 26 53 00 / 26 54 00 / 26 55 00 / 26 55 23 / 26 55 29 / 26 55 33 / 26 55 36 / 26 55 39 / 26 55 53 / 26 55 59 / 26 55 61 / 26 55 63 / 26 55 70

100	See D50	
200	See D5040	
300	Modeled as design-specified size, shape, spacing, and location of lighting fixtures; approximate allowances for spacing and clearances required for all specified hangers, supports and seismic control; access/code clearance requirements modeled.	 <p>197 D5040.50-LOD-300 Lighting Fixtures</p>
350	Modeled as actual size, shape, spacing, and location of lighting fixtures. actual size, shape, spacing, and location for supports and seismic control. actual access/code clearance requirements modeled.	 <p>198 D5040.50-LOD-350 Lighting Fixtures</p>
400	Supplementary components added to the model required for fabrication and field installation.	

Reference Part II Attribute Tables for non-graphical information**D5080 21-04 50 80 Miscellaneous Electrical Systems***Includes: Miscellaneous Electrical Systems Supplementary Components as appropriate.*

Associated Masterformat Sections:

100	See D50	
200	Schematic layout with approximate size, shape, and location of equipment;	

D5080.10 21-04 50 80 10 Lightning Protection*Includes: Wiring and equipment for lightning protection.*

Associated Masterformat Sections: 26 41 00 / 01 86 26 / 26 41 13 / 26 41 16 / 26 41 19 / 26 41 23

100	See D50	
200	See D5080	
300	Modeled as design-specified size, shape, spacing, and location of raceways, boxes, enclosures including the electrical equipment and end-devices served; approximate allowances for spacing and clearances required for all specified hangers, supports and seismic control; access/code clearance requirements modeled.	
350	Modeled as actual size, shape, spacing, and location of raceways, boxes, enclosures including the electrical equipment, fixtures, and end-devices served actual size, shape, spacing, and location for supports and seismic control; actual size, shape, and location/connections of equipment and support structure/pads; actual floor and wall penetration elements are modeled. actual access/code clearance requirements modeled.	
400	Supplementary components added to the model required for fabrication and field installation.	

Reference Part II Attribute Tables for non-graphical information

D5080.70 21-04 50 80 70 Transient Voltage Suppression

Includes: Devices to protect against voltage surges on electrical distribution systems.

Associated Masterformat Sections: 26 43 00

100	See D50	
200	See D5080	
300	Modeled as design-specified size, shape, spacing, and location of equipment; approximate allowances for spacing and clearances required for all specified hangers, supports and seismic control; access/code clearance requirements modeled.	
350	Modeled as actual size, shape, spacing, and location of the equipment; actual size, shape, spacing, and location for supports and seismic control. actual access/code clearance requirements modeled.	
400	Supplementary components added to the model required for fabrication and field installation.	

D60 21-04 60 Communications

Associated Masterformat Sections: 27 00 00 / 01 86 29

[See [Fundamental LOD Definitions](#)]

D6010 21-04 60 10 Data Communications

Includes: Communications Supplementary Components as appropriate.

Associated Masterformat Sections: 27 20 00 / 01 86 29

[See [Fundamental LOD Definitions](#)]

D6020 21-04 60 20 Voice Communications

Includes: Communications Supplementary Components as appropriate.

Associated Masterformat Sections: 27 30 00 / 01 86 29

[See [Fundamental LOD Definitions](#)]

D6030 21-04 60 30 Audio-Video Communication

Includes: Communications Supplementary Components as appropriate.

Associated Masterformat Sections: 27 40 00 / 01 86 29

[See [Fundamental LOD Definitions](#)]

D6060 21-04 60 60 Distributed Communications and Monitoring

Includes: Communications Supplementary Components as appropriate.

Associated Masterformat Sections: 27 50 00 / 01 86 29

[See [Fundamental LOD Definitions](#)]

D6090 21-04 60 90 Communications Supplementary Components

[See [Fundamental LOD Definitions](#)]

Reference Part II Attribute Tables for non-graphical information**D70 21-04 70 Electronic Safety and Security**

Associated Masterformat Sections: 28 00 00 / 01 86 33

[See [Fundamental LOD Definitions](#)]**D7010 21-04 70 10 Access Control and Intrusion Detection***Includes: Electronic Safety and Security Supplementary Components as appropriate.*

Associated Masterformat Sections: 28 10 00 / 01 86 33

[See [Fundamental LOD Definitions](#)]**D7030 21-04 70 30 Electronic Surveillance***Includes: Equipment for detecting and controlling access by persons to a facility site, building, or within a building. Includes Electronic Safety and Security Supplementary Components as appropriate.*

Associated Masterformat Sections: 28 20 00 / 01 86 33

[See [Fundamental LOD Definitions](#)]**D7050 21-04 70 50 Detection and Alarm***Includes: Equipment for detecting hazardous conditions in a building or on a facility site and communicating an alarm signal. Includes alarm devices, detection devices, safety switches, and associated items. Includes Electronic Safety and Security Supplementary Components as appropriate.*

Associated Masterformat Sections: 28 30 00 / 01 86 33

D7070 21-04 70 70 Electronic Monitoring and Control*Includes: Electronic Safety and Security Supplementary Components as appropriate.*

Associated Masterformat Sections: 28 46 00 / 01 86 33

D7090 21-04 70 90 Electronic Safety and Security Supplementary Components**These components are typically modeled as part of other assemblies listed in the tables above. Do not assign this Uniformat classification unless a supplementary component is modeled independently of another assembly.**

Associated Masterformat Sections:

D80 21-04 80 Integrated Automation

Associated Masterformat Sections: 25 00 00 / 01 86 23

[See [Fundamental LOD Definitions](#)]**D8010 21-04 80 10 Integrated Automation Facility Controls***Includes: Hardware and/or software that allows the building automation system to monitor and control other facility equipment and systems. Includes Integrated Automation Supplementary Components as appropriate.*

Associated Masterformat Sections: 25 50 00 / 01 86 23

[See [Fundamental LOD Definitions](#)]

Reference Part II Attribute Tables for non-graphical information

E 21-05 00 00 EQUIPMENT & FURNISHINGS

Associated Masterformat Sections: 01 87 00

E10 21-05 10 Equipment

Associated Masterformat Sections: 11 00 00 / 01 87 13

100	Diagrammatic or schematic model elements: conceptual and/or schematic layout; design performance parameters as defined in the BIMXP to be associated with model elements as non-graphic information.	
-----	--	--

E1010 21-05 10 10 Vehicle and Pedestrian Equipment

Associated Masterformat Sections: 11 10 00

100	See E10	
200	Schematic layout with approximate size, shape, and location of equipment; design performance parameters as defined in the BIMXP to be associated with model elements as non-graphic information.	

E1010.10 21-05 10 10 10 Vehicle Servicing Equipment

Includes: Equipment associated with vehicle service facilities.

Associated Masterformat Sections: 11 11 00 / 11 11 19 / 11 11 23 / 11 11 26

100	See E10	
200	See E1010	
300	Modeled as design-specified size, shape, spacing, and location of equipment and associated components; approximate allowances for spacing and clearances required for all specified supports and seismic control; access/code clearance requirements modeled.	
350	Modeled as actual size, shape, spacing, and location of equipment and associated components; actual size, shape, spacing, and location for supports and seismic control; actual size, shape, and location of service connections and support structure/pads. Actual access/code clearance requirements modeled.	
400	Supplementary components added to the model required for fabrication and field installation.	

E1010.30 21-05 10 10 30 Interior Parking Control Equipment

Includes: Equipment associated with the control of movement of vehicle parking.

Associated Masterformat Sections: 11 12 00 / 11 12 13 / 11 12 16 / 11 12 23 / 11 12 26 / 11 12 33

[See [E1010.10](#)]

E1010.50 21-05 10 10 50 Loading Dock Equipment

Includes: Equipment for the protection of service docks and for the loading and unloading of service vehicles.

Reference Part II Attribute Tables for non-graphical information

Associated Masterformat Sections: 11 13 00 / 11 13 13 / 11 13 16 / 11 13 19.13 / 11 13 19.23 / 11 13 26

[See [E1010.10](#)]

E1010.70 21-05 10 10 70 Interior Pedestrian Control Equipment

Includes: Equipment associated with the control of movement of pedestrians.

Associated Masterformat Sections: 11 14 00 / 11 14 13 / 11 14 16 / 11 14 26 / 11 14 43 / 11 14 53

[See [E1010.10](#)]

E1030 21-05 10 30 Commercial Equipment

Associated Masterformat Sections: 11 20 00

[See [E1010](#)]

E1030.10 21-05 10 30 10 Mercantile and Service Equipment

Includes: Equipment used in retail and service stores.

Associated Masterformat Sections: 11 21 00 / 11 21 13 / 11 21 23 / 11 21 33 / 11 21 43 / 11 21 53

[See [E1010.10](#)]

E1030.20 21-05 10 30 20 Vault Equipment

Includes: Equipment specifically designed for money or valuable material storage, including vault ventilators and specialized security equipment.

Associated Masterformat Sections: 11 16 00 / 11 16 13 / 11 16 16 / 11 16 23

[See [E1010.10](#)]

E1030.25 21-05 10 30 25 Teller and Service Equipment

Includes: Equipment specifically designed for handling and transfer of money and other high-security items.

Associated Masterformat Sections: 11 17 00 / 11 17 13 / 11 17 16 / 11 17 23 / 11 17 33 / 11 17 36

[See [E1010.10](#)]

E1030.30 21-05 10 30 30 Refrigerated Display Equipment

Includes: Display cases that include refrigeration.

Associated Masterformat Sections: 11 22 00

[See [E1010.10](#)]

Reference Part II Attribute Tables for non-graphical information**E1030.35 21-05 10 30 35 Commercial Laundry and Dry Cleaning Equipment**

Includes: Equipment for commercial laundry and dry cleaning operations including coin-operated equipment.

Associated Masterformat Sections: 11 23 00 / 11 23 13 / 11 23 16 / 11 23 19 / 11 23 23 / 11 23 26 / 11 23 33 / 11 23 43

[See [E1010.10](#)]

E1030.40 Maintenance Equipment

Includes: Built-in and free-standing equipment for building maintenance.

Associated Masterformat Sections: 11 24 00 / 11 24 13 / 11 24 16 / 11 24 19 / 11 24 23.13

[See [E1010.10](#)]

E1030.50 21-05 10 30 50 Hospitality Equipment

Includes: Specialized equipment for the purpose of registering, admitting, and controlling rooms and other information at hotels, motels, hospitals, and other similar facilities.

Associated Masterformat Sections: 11 25 00 / 11 25 13

[See [E1010.10](#)]

E1030.55 21-05 10 30 55 Unit Kitchens

Includes: Manufactured units incorporating plumbing fixtures, appliances, casework and countertops.

Associated Masterformat Sections: 11 26 00

[See [E1010.10](#)]

E1030.60 21-05 10 30 60 Photographic Processing Equipment

Includes: Photographic film processing equipment and other products for darkroom use.

Associated Masterformat Sections: 11 27 00 / 11 27 13 / 11 27 16

[See [E1010.10](#)]

E1030.70 21-05 10 30 70 Postal, Packaging and Shipping Equipment

Includes: Equipment for normal mailing, packaging, shipping, and delivery operations for professional, commercial, and institutional applications.

Associated Masterformat Sections: 11 29 00 / 11 29 23 / 11 29 33 / 11 29 55 / 11 28 23

[See [E1010.10](#)]

E1030.75 21-05 10 30 75 Office Equipment

Includes: Computers, printers, copiers, drafting equipment, plotters, carto-stereographs, and other equipment used in offices.

Associated Masterformat Sections: 11 28 00 / 11 28 13 / 11 28 16 / 11 28 19 / 11 28 23

[See [E1010.10](#)]

Reference Part II Attribute Tables for non-graphical information

E1030.80 21-05 10 30 80 Foodservice Equipment

Includes: Equipment used for liquid and solid food storage, preparation, display, serving, and clean-up in commercial and institutional kitchens and bars.

Associated Masterformat Sections: 11 40 00 / 11 41 00 / 11 41 13 / 11 41 23 / 11 41 26 / 11 41 33 / 11 42 00 / 11 43 00 / 11 41 13 / 11 41 16 / 11 44 00 / 11 44 13 / 11 44 16 / 11 46 00 / 11 46 13 / 11 46 16 / 11 46 19 / 11 47 00 / 11 48 00 / 11 48 13

[See [E1010.10](#)]

E1040 21-05 10 40 Institutional Equipment

Associated Masterformat Sections: 11 50 00

[See [E1010](#)]

E1040.10 21-05 10 40 10 Educational and Scientific Equipment

Includes: Equipment associated with libraries, education facilities, laboratories, planetariums, observatories, and museums.

Associated Masterformat Sections: 11 50 00 / 11 51 00 / 11 51 13 / 11 51 16 / 11 51 19 / 11 51 23 / 11 52 00 / 11 52 13 / 11 52 16 / 11 52 19 / 11 53 00 / 11 53 13 / 11 53 16 / 11 53 19 / 11 53 23 / 11 53 33 / 11 53 43 / 11 53 53 / 11 55 00 / 11 55 13 / 11 55 16 / 11 56 00 / 11 56 13 / 11 57 00 / 11 59 00 / 11 95 00 / 11 95 13

[See [E1010.10](#)]

E1040.20 21-05 10 40 20 Healthcare Equipment

Includes: Specialized equipment for healthcare facilities for humans and animals. Includes film illuminators, fluoroscopes, hubbard tubs, radio isotopic equipment, and surgical equipment.

Associated Masterformat Sections: 11 70 00 / 05 45 23 / 11 71 00 / 11 72 00 / 11 73 00 / 11 74 00 / 11 75 00 / 11 76 00 / 11 77 00 / 11 78 00 / 11 78 13 / 11 78 16 / 11 78 19 / 11 79 00

[See [E1010.10](#)]

E1040.40 21-05 10 40 40 Religious Equipment

Includes: Built-in and free-standing religious equipment, including baptistery and chancel fittings.

Associated Masterformat Sections: 11 91 00 / 11 91 13

[See [E1010.10](#)]

E1040.60 21-05 10 40 60 Security Equipment

Includes: Equipment specifically designed for secure operations.

Associated Masterformat Sections: 11 18 00 / 11 18 13 / 11 18 16 / 11 18 23

[See [E1010.10](#)]

E1040.70 21-05 10 40 70 Detention Equipment

Includes: Equipment specifically designed for detention facilities.

Associated Masterformat Sections: 11 19 00 / 01 87 13 / 11 19 13 / 11 19 16

[See [E1010.10](#)]

E1060 21-05 10 60 Residential Equipment

Includes: Built-in and free-standing appliances and other components specifically for residential use.

Associated Masterformat Sections: 11 30 00

[See [E1010](#)]

Reference Part II Attribute Tables for non-graphical information

E1060.10 21-05 10 60 10 Residential Appliances

Associated Masterformat Sections: 11 31 00 / 11 31 13 / 11 31 23

[See [E1010.10](#)]

E1060.50 21-05 10 60 50 Residential Stairs

Associated Masterformat Sections: 11 33 00

[See [B1080](#)]

E1060.70 21-05 10 60 70 Residential Ceiling Fans

Associated Masterformat Sections: 11 34 00

[See [E1010.10](#)]

E1070 21-05 10 70 Entertainment and Recreational Equipment

Includes: Equipment for use in athletic, recreational, and therapeutic activities.

Associated Masterformat Sections:

[See [E1010](#)]

E1070.10 21-05 10 70 10 Theater and Stage Equipment

Includes: Equipment for support of theatrical, instrumental, and voice programs. Includes cycloramas, entertainment ticket dispensers, scenery and flats, and tormentors.

Associated Masterformat Sections: 11 61 00 / 11 61 13 / 11 61 23 / 11 61 33 / 11 61 43

[See [E1010.10](#)]

E1070.20 21-05 10 70 20 Musical Equipment

Includes: Musical instruments, including prefabricated and field assembled instruments.

Associated Masterformat Sections: 11 62 00 / 11 62 13 / 11 62 16 / 11 62 19

[See [E1010.10](#)]

E1070.50 21-05 10 70 50 Athletic Equipment

Includes: Equipment for use in interior athletic and exercise activities.

Associated Masterformat Sections: 11 66 00 / 11 66 13 / 11 66 23 / 11 66 43 / 11 66 53

[See [E1010.10](#)]

E1070.60 21-05 10 70 60 Recreational Equipment

Includes: Equipment for use in recreational activities. Includes curling rinks and pistol and rifle range equipment.

Associated Masterformat Sections: 11 67 00 / 11 67 13 / 11 67 23 / 11 67 33 / 11 67 43 / 11 67 53

[See [E1010.10](#)]

E1090 21-05 10 90 Other Equipment

Associated Masterformat Sections: 11 90 00

[See [E1010](#)]

E1090.10 21-05 10 90 10 Solid Waste Handling Equipment

Includes: Equipment involving the collection, shredding, compaction, removal and incineration of trash and other solid waste

Associated Masterformat Sections: 11 82 00 / 01 87 13 / 11 82 13 / 11 82 19 / 11 82 23 / 11 82 26 / 11 82 29 / 11 82 33 / 11 82 36

[See [E1010.10](#)]

Reference Part II Attribute Tables for non-graphical information

E1090.30 21-05 10 90 30 Agricultural Equipment

Includes: Equipment related to land cultivating, raising crops, and feeding, breeding, and raising of livestock.

Associated Masterformat Sections: 11 92 00 / 11 92 13 / 11 92 16 / 11 92 19 / 11 92 23

[See [E1010.10](#)]

E1090.40 21-05 10 90 40 Horticultural Equipment

Includes: Equipment related to cultivating flowers, fruits, vegetables, or ornamental plants.

Associated Masterformat Sections: 11 93 00 / 11 93 13 / 11 93 16 / 11 93 19 / 11 93 23 / 11 93 26 / 11 93 29 / 11 93 33 / 32 86 00

[See [E1010.10](#)]

E1090.60 21-05 10 90 60 Decontamination Equipment

Includes: Equipment associated with decontamination operations.

Associated Masterformat Sections:

[See [E1010.10](#)]

E20 21-05 20 Furnishings

Associated Masterformat Sections: 12 00 00 / 01 87 16

100	A schematic model element or symbol that is not distinguishable by type or material. Types, layouts, and locations are still flexible.	
-----	---	--

E2010 21-05 20 10 Fixed Furnishings

Associated Masterformat Sections:

100	See E20	
200	Generic model elements with approximate nominal size. Placement and quantity remains flexible. •	

Reference Part II Attribute Tables for non-graphical information

E2010.10 21-05 20 10 10 Fixed Art

Includes: Interior and exterior fixed art objects.

Associated Masterformat Sections: 12 10 00 / 12 11 00 / 12 12 00 / 12 12 23 / 12 12 26 / 12 14 00 / 12 17 00 / 12 19 00

100	See E20	
200	See E2010	
300	Modeled types with specific dimensions, locations, and quantities.	
350	Include any applicable service or installation clearances. Include any applicable support and connection points.	
400	Supplementary components added to the model required for fabrication and field installation.	

E2010.20 21-05 20 10 20 Window Treatments

Includes: Interior window coverings and associated hardware and controls.

Associated Masterformat Sections: 12 20 00 / 12 21 00 / 12 22 00 / 12 23 00 / 12 24 00 / 12 25 00

[See [E2010.10](#)]

E2010.30 21-05 20 10 30 Casework

Includes: Custom and manufactured stock design steel, wood, and laminate faced cabinets and other casework units. Includes countertops with integral sinks, fixtures and accessories.

Associated Masterformat Sections: 12 30 00 / 12 35 00 / 12 35 17 / 12 35 25 / 12 35 30 / 12 35 33 / 12 35 50 / 12 35 53 / 12 35 59 / 12 35 70 / 12 35 91 / 12 36 00

[See [E2010.10](#)]

E2010.70 21-05 20 10 70 Fixed Multiple Seating

Includes: Fixed, and telescoping seating for theaters, auditoriums, lecture halls, stadiums, arenas, gymnasiums, religious buildings, restaurants, and other facilities where multiple seating is required.

Associated Masterformat Sections: 12 60 00 / 12 61 00 / 12 63 00 / 13 34 16.53 / 12 64 00 / 12 65 00 / 12 66 00 / 12 67 00 / 12 68 00

[See [E2010.10](#)]

E2010.90 21-05 20 10 90 Other Fixed Furnishings

Includes: Fixed artificial plants, planters, and accessories.

Associated Masterformat Sections: 12 90 00 / 12 92 00 / 12 92 13 / 12 92 33 / 12 92 43

[See [E2010.10](#)]

E2050 21-05 20 50 Movable Furnishings

Includes: Items of moveable furniture and furnishing accessories. Includes furniture for a variety of uses including classroom, dormitory, ecclesiastical, hotel and motel, laboratory, library, lounge, medical, office, restaurant, and residential.

Associated Masterformat Sections:

[See [E2010](#)]

E2050.10 21-05 20 50 10 Movable Art

Includes: Interior and exterior moveable art objects such as paintings, and sculpture.

Associated Masterformat Sections: 12 10 00 / 12 14 00 / 12 19 00

[See [E2010.10](#)]

E2050.30 21-05 20 50 30 Furniture

Includes: Movable interior furniture.

Associated Masterformat Sections: 12 50 00 / 12 51 00 / 12 52 00 / 12 52 23 / 12 52 70 / 12 53 00 / 12 54 00 / 12 54 13 / 12 54 16 / 12 55 00 / 12 56 00 / 12 56 33 / 12 56 39 /

Reference Part II Attribute Tables for non-graphical information

12 56 43 / 12 56 51 / 12 56 52 / 12 56 53 / 12 56 70 / 12 57 00 / 12 57 13 / 12 57 16 /
12 58 00 / 12 59 00

[See [E2010.10](#)]

E2050.40 21-05 20 50 40 Accessories

Includes: Interior furnishing accessories not attached to permanent construction.

*Associated Masterformat Sections: 12 40 00 / 12 41 00 / 12 42 00 / 12 43 00 / 12 44 00 /
12 44 16 / 12 45 00 / 12 46 00 / 12 48 00*

[See [E2010.10](#)]

E2050.60 21-05 20 50 60 Movable Multiple Seating

Includes: Portable seating for auditoriums, lecture halls, stadiums, arenas, gymnasiums, religious buildings, restaurants, and other facilities where multiple seating is required.

Associated Masterformat Sections: 12 60 00 / 12 62 00 / 12 65 00 / 12 67 00 / 12 68 00

[See [E2010.10](#)]

E2050.90 21-05 20 50 90 Other Movable Furnishings

Includes: Moveable artificial plants, and planters.

Associated Masterformat Sections: 12 90 00 / 12 92 00 / 12 92 13 / 12 92 33 / 12 92 43

[See [E2010.10](#)]

Reference Part II Attribute Tables for non-graphical information

F 21-06 00 00 SPECIAL CONSTRUCTION & DEMOLITION

Associated Masterformat Sections:

F10 21-06 10 Special Construction

Associated Masterformat Sections: 01 88 13

F1010 21-06 10 10 Integrated Construction

Associated Masterformat Sections:

[See [Fundamental LOD Definitions](#)]

F1020 21-06 10 20 Special Structures

Associated Masterformat Sections: 13 30 00 / 01 88 13

[See [Fundamental LOD Definitions](#)]

F1020.40 21-06 10 20 40 Special Structures: Metal Building Systems

Includes: Prefabricated buildings and structures assembled on temporary and permanent foundations.

Associated Masterformat Sections: 13 34 00 / 01 88 13 / 13 34 13 / 13 34 16 / 13 34 19 / 13 34 56

100	Generic mass of special structure with system typically noted with a design narrative for conceptual pricing.	 <p style="text-align: right;"><i>199 F1020.40-LOD 100 Metal Building Systems</i></p>
-----	---	--

F1020.40.10 21-06 10 20 40 Special Structures: Metal Building Systems - Primary Framing and Bracing

Includes: Prefabricated buildings and structures assembled on temporary and permanent foundations.

Associated Masterformat Sections: 13 34 00 / 01 88 13 / 13 34 13 / 13 34 16 / 13 34 19 / 13 34 56

Reference Part II Attribute Tables for non-graphical information

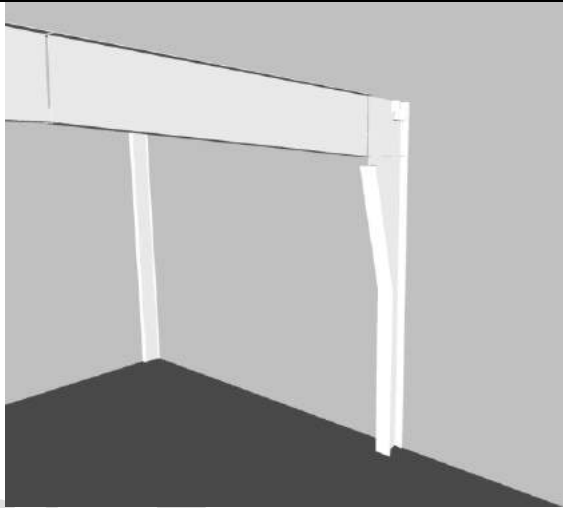
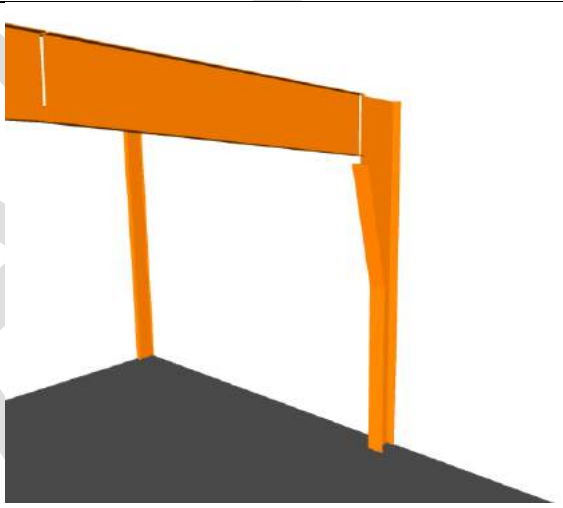
<p>200</p>	<p>Generic mass of frame shown in an approximate location, and a general span/direction with a design narrative for conceptual pricing.</p> <p>Model elements to include:</p> <ul style="list-style-type: none"> • Framing grids defined. Sections shapes shown but profiles, tapers and plate thicknesses and flange widths still flexible. 	 <p>200 F1020.40-LOD 200 Metal Building Systems - Primary Framing</p>
<p>300</p>	<p>Metal Building System components including:</p> <ul style="list-style-type: none"> • Endwall or wind column • End frame main members • Module or interior columns • Frames and main members <ul style="list-style-type: none"> ○ Columns ○ Rafters • Roof and wall diagonal bracing • Crane beams <p>Element modeling to include:</p> <ul style="list-style-type: none"> • Specific sizes of frame structural members, all with correct orientation • Web tapers • Any lateral bracing components connecting to frame or foundation (i.e., portal frames, fixed base columns, diagonal bracing - rods or cables, struts) all with specific sizes and orientation. 	 <p>201 F1020.40-LOD 300 Metal Building Systems - Primary Framing</p>

Reference Part II Attribute Tables for non-graphical information

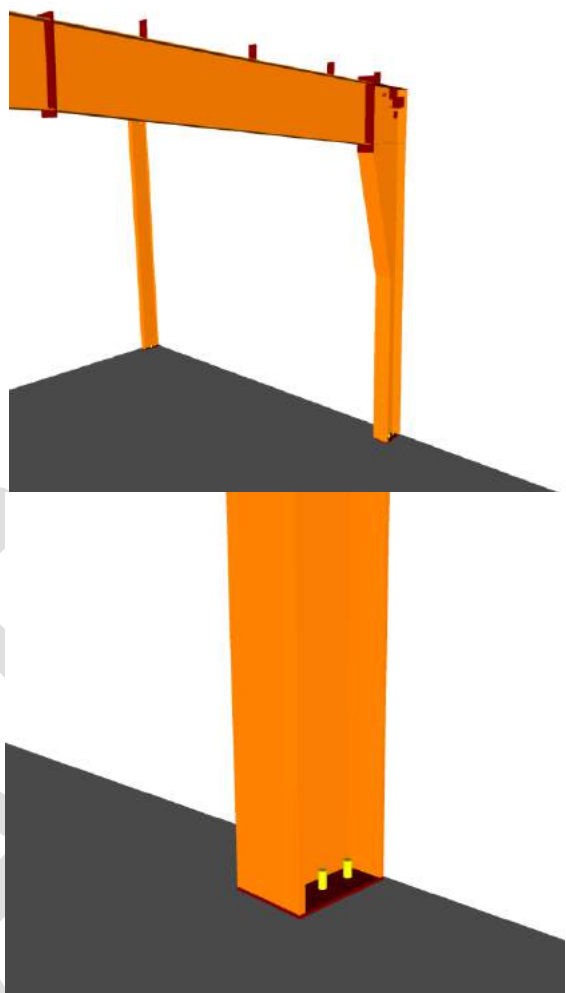
<p>350</p>	<p>Element modeling to include:</p> <ul style="list-style-type: none"> • Base plate locations • Bracing components (i.e. gussets) • Critical or large elements of connections applied to all structural steel connections such as base plates, gusset plates, anchor rods, etc. • Clips required for connection to secondary framing • Any miscellaneous steel members with correct orientation required for the frame structure. (i.e., roof beams, spandrels) • Any steel structure reinforcement such as web stiffeners, connection plate stiffeners, sleeve penetrations, etc. required for coordination. 	 <p>202 F1020.40-LOD 350 Metal Building Systems - Primary Framing</p>
------------	---	--

Reference Part II Attribute Tables for non-graphical information

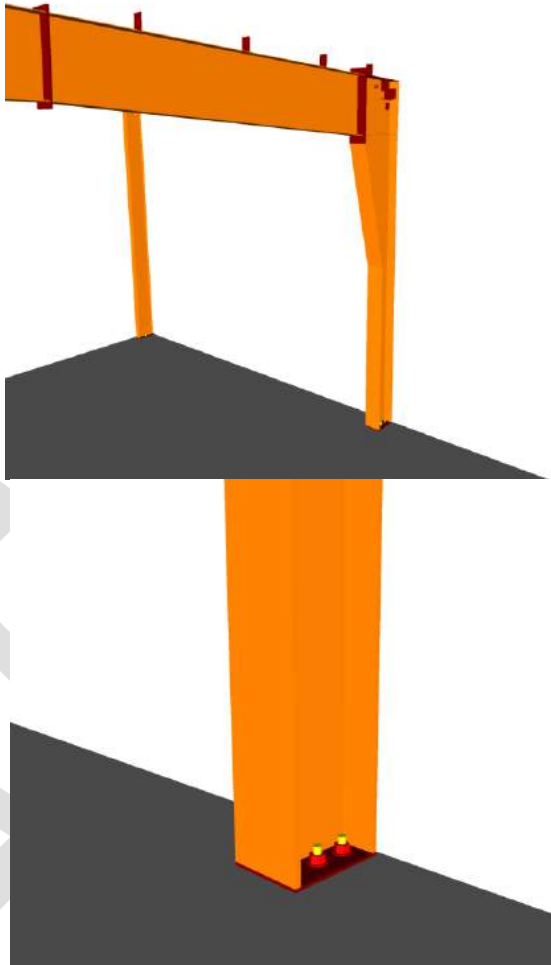
<p>400</p>	<p>Element modeling to include fabrication level information:</p> <ul style="list-style-type: none">• Welds• Reinforcement plates• Coping of members• Bolts, nuts, washers, etc.• Holes, slots, etc., including holes for future element attachments• All assembly elements	 <p>203 F1020.40-LOD 400 Metal Building Systems - Primary Framing</p>
------------	--	--

Reference Part II Attribute Tables for non-graphical information

F1020.40.20 21-06 10 20 40 **Special Structures: Metal Building Systems - Secondary Framing**

Includes: Prefabricated buildings and structures assembled on temporary and permanent foundations.

Associated Masterformat Sections: 13 34 00 / 01 88 13 / 13 34 13 / 13 34 16 / 13 34 19 / 13 34 56

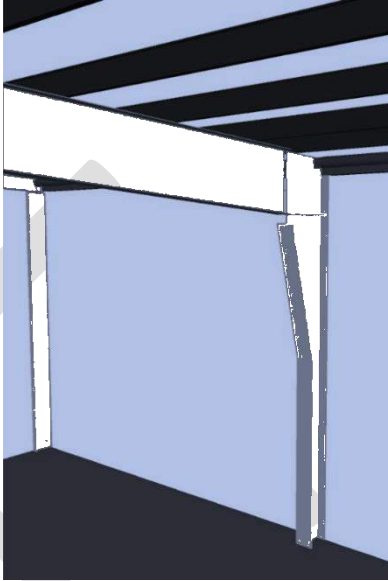
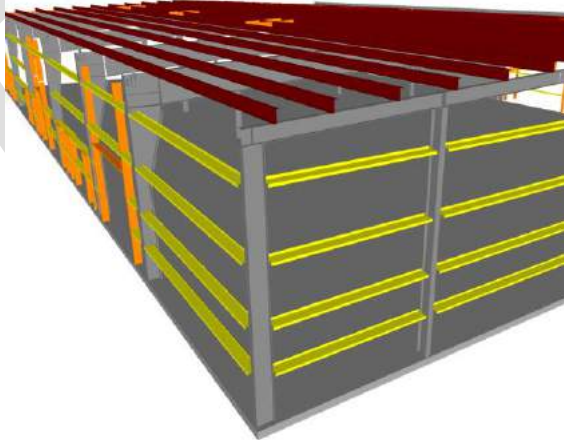
<p>200</p>	<p>Generic mass of special structure with system typically noted with a design narrative for conceptual pricing. Generic open wall conditions identified (i.e., open for material by others, open for passage, etc.)</p> <p>Approximate overall depth and extent represented by secondary roof and wall framing members.</p>	 <p>204 F1020.40-LOD 200 Metal Building Systems - Secondary Framing</p>
<p>300</p>	<p>Metal Building System components, including:</p> <ul style="list-style-type: none"> • Purlins and bridging • Eave strut • Sidewall girts • Endwall girts • Sag braces • Framed openings (jambes, headers, etc.) • Window sub-frames • Walk door sub-frames <p>Element modeling to include:</p> <ul style="list-style-type: none"> • Specific sizes of main structural members, (mass for open web members), all with correct orientation 	 <p>205 F1020.40-LOD 300 Metal Building Systems - Secondary Framing</p>

Reference Part II Attribute Tables for non-graphical information

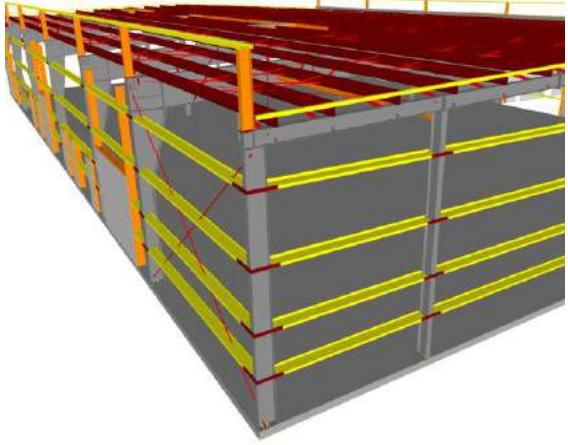
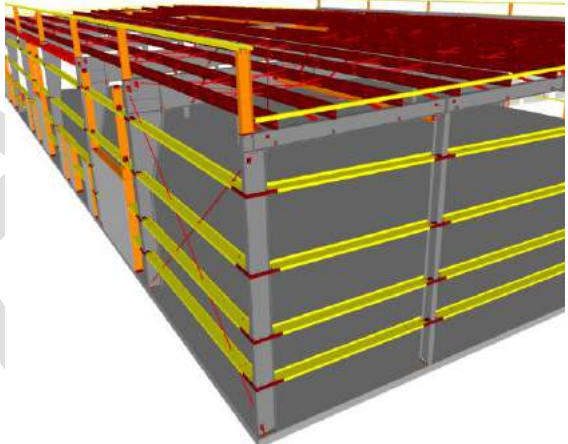
350	<p>Element modeling to include:</p> <ul style="list-style-type: none"> • Nested members • Connections for member bracing • Clips joining secondary framing members • Large elements of typical connections applied to all secondary steel connections such as girt to column, purlin to rafter, jamb to girt, header to jamb, etc. • Secondary angles, including sheeting angles and rake angles • Base attachment members • Any miscellaneous secondary steel members with correct orientation, i.e. canopies, parapets, door framing, etc. • Web members and bridging for open web purlins • For bar joist, see Steel Open Web Joists LOD. 	 <p>206 F1020.40-LOD 350 Metal Building Systems-Secondary Framing</p>
400	<p>Element modeling to include fabrication level information:</p> <ul style="list-style-type: none"> • Welds • Bolts, nuts, washers, screws, and fasteners • Coping of members • Holes cut for bracing • Nested member attachments • All assembly elements 	 <p>207 F1020.40-LOD 400 Metal Building Systems - Secondary Framing</p>

Reference Part II Attribute Tables for non-graphical information

F1020.40.30 21-06 10 20 40 Special Structures: Metal Building Systems - Cladding and Exterior Trim

Includes: Prefabricated buildings and structures assembled on temporary and permanent foundations.

Associated Masterformat Sections: 13 34 00 / 01 88 13 / 13 34 13 / 13 34 16 / 13 34 19 / 13 34 56

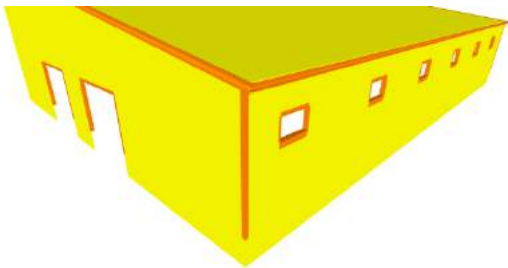
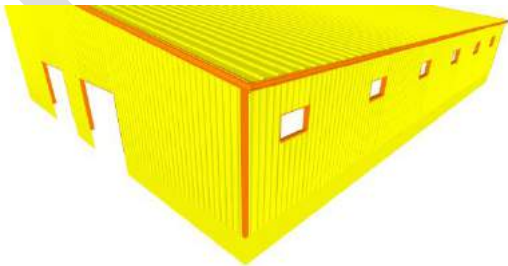
<p>200</p>	<p>Element modeling to include:</p> <ul style="list-style-type: none"> • Panel: <ul style="list-style-type: none"> ○ Generic mass of panel with a generic profile or graphical texture shown, ○ Openings/Voids are represented, identifying cladding boundaries within the wall/roof plane. • Trim: <ul style="list-style-type: none"> ○ Major exterior trim used to separate roof and walls and trim used for aesthetic accent, represented by a generic trim profile. 	 <p><i>208 F1020.40-LOD 200 Metal Building Systems – Cladding and Exterior Trim</i></p>
<p>300</p>	<p>Element modeling to include:</p> <ul style="list-style-type: none"> • Panel: <ul style="list-style-type: none"> ○ Panel with actual profile or graphical texture shown, filling the boundary set by the plane object. ○ Significant accessories (i.e., light transmitting panels, ridge vents, curbs) shown ○ Openings/Voids are represented in true dimensions/locations. • Trim: <ul style="list-style-type: none"> ○ Major trims (primary exterior pieces) are shown, represented by the actual trim profile, thickness, and color. <ul style="list-style-type: none"> ▪ Gutters ▪ Corner boxes ▪ Corners ▪ Open wall trim ▪ Framed opening trim 	 <p><i>209 F1020.40-LOD 300 Metal Building Systems – Cladding and Exterior Trim</i></p>

Reference Part II Attribute Tables for non-graphical information

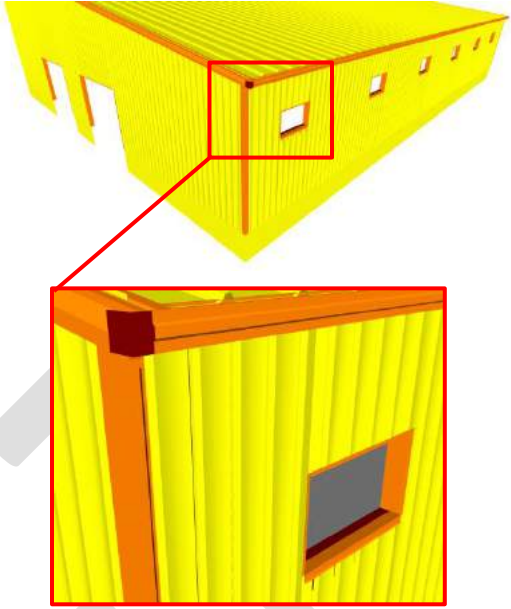
<p>350</p>	<p>Element modeling to include:</p> <ul style="list-style-type: none"> • Panel: <ul style="list-style-type: none"> ○ Actual profile modeled filling the boundary set by the plane object. ○ Closures ○ Downspouts • Trim: <ul style="list-style-type: none"> ○ Minor trims (end caps, transition pieces, etc.) are shown. 	 <p><i>210 F1020.40-LOD 350 Metal Building Systems – Cladding and Exterior Trim</i></p>
<p>400</p>	<p>Element modeling to include fabrication level information:</p> <ul style="list-style-type: none"> • Panel: <ul style="list-style-type: none"> ○ Individual panel objects, with actual profile shown, positioned accurately within the building plane boundary and shown at installed length. ○ Fasteners at critical locations ○ Closures ○ Cinch straps ○ Caulk/mastic and other field-installed weather-tightness materials shown at critical locations • Trim: <ul style="list-style-type: none"> ○ Minor trims (end caps, transition pieces, etc.) are shown accurately. ○ Attachment or accessories (fasteners, etc.) shown at critical locations. ○ Caulk/mastic and other field-installed weather-tightness materials shown at critical locations 	

Reference Part II Attribute Tables for non-graphical information

F1030 21-06 10 30 Special Function Construction

Associated Masterformat Sections:

[See [Fundamental LOD Definitions](#)]

F1050 21-06 10 50 Special Facility Components

Associated Masterformat Sections:

[See [Fundamental LOD Definitions](#)]

F1060 21-06 10 60 Athletic and Recreational Special Construction

Includes: Special construction for athletic and recreational activities that are directly related to the adjacent construction.

Associated Masterformat Sections: 13 28 00

[See [Fundamental LOD Definitions](#)]

F1080 21-06 10 80 Special Instrumentation

Includes: Instrumentation for measuring and recording phenomena such as stresses in structures, solar and wind energy, and effects of earthquakes.

Associated Masterformat Sections: 13 50 00

[See [Fundamental LOD Definitions](#)]

F20 21-06 20 Facility Remediation

Associated Masterformat Sections:

F2010 21-06 20 10 Hazardous Materials Remediation

Includes: Remediation for abatement and removal and disposal of contaminated materials within structures.

Associated Masterformat Sections: 02 80 00

[See [Fundamental LOD Definitions](#)]

F30 21-06 30 Demolition

Associated Masterformat Sections:

F3010 21-06 30 10 Structure Demolition

Includes: Complete removal and disposal of structures.

Associated Masterformat Sections: 02 41 16

[See [Fundamental LOD Definitions](#)]

F3030 21-06 30 30 Selective Demolition

Includes: Removal and disposal of parts of structures.

Associated Masterformat Sections: 02 41 19

[See [Fundamental LOD Definitions](#)]

F3050 21-06 30 50 Structure Moving

Includes: Preparation and processes of relocating and raising structures.

Associated Masterformat Sections: 02 43 00

[See [Fundamental LOD Definitions](#)]

Reference Part II Attribute Tables for non-graphical information

G 21-07 00 00 BUILDING SITEWORK

Associated Masterformat Sections: 01 89 00

G10 21-07 10 Site Preparation

Associated Masterformat Sections: 01 89 13

100	A simple topographic surface is provided.	 <p>211 G10-LOD-100 Site Preparation</p>
200	<p>Element modeling to include:</p> <ul style="list-style-type: none"> • Approximate size and shape of foundation element • Approximate size/location of utilities and structures • Approximate code and clearance requirements • Approximate pipe material • Rough modeling of site grading 	

G1010 21-07 10 10 Site Clearing

Includes: Removal of vegetation from the site, including stripping of sod and soil, and tree pruning for site clearing.

Associated Masterformat Sections: 31 10 00 / 31 11 00 / 31 13 00 / 31 14 00 / 31 14 13
31 14 16

G1020 21-07 10 20 Site Elements Demolition

Includes: Removal of above and below grade site improvements.

Associated Masterformat Sections: 02 41 13

G1030 21-07 10 30 Site Element Relocations

Includes: Relocation of utility systems.

G1050 21-07 10 50 Site Remediation

Includes: Remediation of contaminated sites.

Associated Masterformat Sections: 02 50 00 / 01 89

G1070 21-07 10 70 Site Earthwork

Includes: Moving earth to establish new contours and elevations.

Associated Masterformat Sections: 31 20 00 / 01 89 13

Reference Part II Attribute Tables for non-graphical information**G1070.10 21-07 10 70 10 Grading***Includes: Earthmoving to reshape contours.*

Associated Masterformat Sections: 31 20 00 / 01 89 13

100	<p>Existing Surface: 3D surface generated from site topography, with grade breaks and lines as needed to define accurate surface. 3D site features included if provided by surveyor (i.e. walls, signage, stairs, etc., as defined in Survey LOC-Grade)</p> <p>Proposed Surface: Generic Surface Interpolation between the following elements: Building Envelope at Finish Floor, Finish Grade at Retaining Walls, Grading Limits</p> <p>Local Coordinate Control. Shared Coordinate from Building Grid base point to real-world project control</p>	
200	<p>Existing Surface: Added definition from supplemental survey, revised limits of work</p> <p>Proposed Surface: Added definition including curbs, hardscape, finish surface at building envelopes (to correspond to stem walls/deepened footings).</p>	
300	<p>Existing Surface: Added definition from supplemental survey, revised limits of work</p> <p>Proposed Surface: Complete and accurate surface definition based on defined fine grading, grade breaks, curbs, hardscape, buildings, swales, etc.</p>	

G20 21-07 20 Site Improvements

Associated Masterformat Sections: 01 89 16

100	Diagrammatic or schematic model elements.	
200	<p>Element modeling to include:</p> <ul style="list-style-type: none"> • Approximate size and shape of foundation element • Approximate size/location of utilities and structures • Approximate code and clearance requirements • Approximate pipe material • Rough modeling of site grading • Local structural building grids defined in model and coordinated with global state plane coordinate system for site model. 	

G2010 21-07 20 10 Roadways*Includes: Pavement, curbs and gutters, appurtenances, lighting, and vehicle fare collection for roadways. May Include: Site earthwork.*

Associated Masterformat Sections: 01 89 16

[See [Fundamental LOD Definitions](#)]**G2020 21-07 20 20 Parking Lots***Includes: Pavement, curbs and gutters, appurtenances, lighting, and parking control equipment for parking lots. May Include: Site earthwork*

Associated Masterformat Sections: 01 89 16

[See [Fundamental LOD Definitions](#)]

Reference Part II Attribute Tables for non-graphical information

G2020.10 21-07 20 20 10 Parking Lot Pavement

Includes: Prepared and compacted soil and granular layers placed prior to installation of parking lot pavement. Includes: Finished parking lot pavement of granular and asphaltic materials. Includes: Finished parking lot pavement with high bending resistance, usually of concrete. Includes: Blocks or tiles used for parking lot pavement. Unit pavers set in mastic, sand, or mortar.

Associated Masterformat Sections: 32 10 00 / 32 12 00 / 32 13 00 / 32 14 00 / 32 15 00

100	See G20	
200	See G20	
300	Specific thickness of pavement and substrate modeled. All drainage slopes modeled.	
350	Openings for drains and other services modeled.	

G2020.20 21-07 20 20 20 Parking Lot Curbs and Gutters

Includes: Construction at perimeter of parking lot pavement to separate pavement from adjacent surfaces, provide vehicular restraint, and facilitate drainage.

Associated Masterformat Sections: 32 16 13

100	See G20	
200	See G20	
300	Full extents of curbs and gutters (above and below grade) are modeled.	
350	Element modeling to include: <ul style="list-style-type: none"> • Reinforcing • Pour stops • Expansion joints 	

G2020.40 21-07 20 20 40 Parking Lot Appurtenances

Includes traffic signals, signage, striping.

Associated Masterformat Sections: 32 17 00 / 32 17 13 / 32 17 43 / 10 14 53 / 32 17 23

G2030 21-07 20 30 Pedestrian Plazas and Walkways

Includes: Pavement, curbs and gutters, appurtenances, lighting, and pedestrian control equipment for pedestrian plazas and walkways. Includes exterior steps and ramps. May Include: Site earthwork.

Associated Masterformat Sections: 01 89 16

G2040 21-07 20 40 Airfields

Includes: Pavement, curbs and gutters, appurtenances, lighting, and airfield signally and control equipment for airfields. May Include: Site earthwork.

Associated Masterformat Sections: 01 89 16

G2050 21-07 20 50 Athletic, Recreational, and Playfield Areas

Includes: Surfacing, fencing, equipment, grandstands and bleachers, and lighting for athletic, recreational, and playfield areas. May Include: Site earthwork.

Associated Masterformat Sections: 01 89 16

G2060 21-07 20 60 Site Development

[See [Fundamental LOD Definitions](#)]

G2080 21-07 20 80 Landscaping

[See [Fundamental LOD Definitions](#)]

Reference Part II Attribute Tables for non-graphical information**G30 21-07 30 Liquid and Gas Site Utilities**

Associated Masterformat Sections: 01 89 19

100	Narrative that references the grading model	
200	Approximate sizes, vertical control, and apparatus.	

G3010 21-07 30 10 Water Utilities

Includes: Water distribution for domestic consumption, fire fighting, and irrigation for a facility site and for multiple facilities. Includes trenching and backfilling. Includes Liquid and Gas Site Utilities Supplementary Components as appropriate.

Associated Masterformat Sections: 33 10 00

100	See G30	
200	See G30	

G3010.10 21-07 30 10 10 Site Domestic Water Distribution

Includes: Supply wells, piping, equipment, storage tanks, and water ponds and reservoirs.

Associated Masterformat Sections: 01 89 19 / 33 21 00 / 33 11 00 / 33 12 00 / 33 12 13 / 33 12 16 / 33 12 19 / 33 12 23 / 33 12 33 / 33 13 00 / 33 16 00 / 33 47 19.13 / 33 47 13.13 / 33 47 16.13

100	See G30	
200	See G30	

G3010.30 21-07 30 10 30 Site Fire Protection Water Distribution

Includes: Supply wells, piping, equipment, storage tanks, and water ponds and reservoirs.

Associated Masterformat Sections: 01 89 19 / 33 21 00 / 33 11 19 / 33 12 00 / 33 12 13 / 33 12 16 / 33 12 19 / 33 12 23 / 33 12 33 / 33 16 00 / 33 47 19.33 / 33 47 13.13 / 33 47 16.13

100	See G30	
200	See G30	

G3020 21-07 30 20 Sanitary Sewerage Utilities

Includes: Sanitary sewerage for a facility site and for multiple facilities. Includes piping, septic tanks that serve multiple facilities, structures, and lagoons. Includes trenching and backfilling. Includes Liquid and Gas Site Utilities Supplementary Components as appropriate.

Associated Masterformat Sections: 33 30 00 / 01 89 19

100	See G30	
200	See G30	

G3020.20 21-07 30 20 20 Sanitary Sewerage Piping

Associated Masterformat Sections: 33 31 00 / 33 33 00 / 33 34 00

100	See G30	
200	See G30	
300	Specific elevations, sizes, materials	

Reference Part II Attribute Tables for non-graphical information**G3020.50 21-07 30 20 50 Sanitary Sewerage Structures**

Associated Masterformat Sections: 33 39 00 / 33 39 13 / 33 39 23

100	See G30	
200	Approximate structure types, sizes and materials	
300	Specific structure elements at all locations, specific sizes and materials	

G3030 21-07 30 30 Storm Drainage Utilities

Includes: Storm drainage for surface or combination of surface and subsurface water for a facility site or for multiple facilities. Includes piping, culverts, water drains, drainage pumps, Subdrainage, and storm drainage ponds and reservoirs. Includes trenching and backfilling. Includes Liquid and Gas Site Utilities Supplementary Components as appropriate.

Associated Masterformat Sections: 01 89 19

100	See G30	
200	See G30	

G3050 21-07 30 50 Site Energy Distribution

Includes: Energy distribution for a facility site or multiple facilities. Includes hydronic heating, steam energy, and hydronic cooling distribution. Includes trenching and backfilling. Includes Liquid and Gas Site Utilities Supplementary Components as appropriate.

100	See G30	
200	See G30	

G3060 21-07 30 60 Site Fuel Distribution

Includes: Gas, fuel-oil, gasoline, diesel fuel, and aviation fuel distribution for a facility site or multiple facilities. Includes trenching and backfilling. Includes Liquid and Gas Site Utilities Supplementary Components as appropriate.

100	See G30	
200	See G30	

G3090 21-07 30 90 Liquid and Gas Site Utilities Supplementary Components

Includes: Common work results for utilities and instrumentation and control to be included in liquid and gas utility elements above as appropriate.

These components are typically modeled as part of other assemblies listed in the tables above. Do not assign this Uniformat classification unless a supplementary component is modeled independently of another assembly.

G40 21-07 40 Electrical Site Improvements

Associated Masterformat Sections: 01 89 26



100	Diagrammatic or schematic model elements: conceptual and/or schematic layout; design performance parameters as defined in the BIMXP to be associated with model elements as non-graphic information.	
-----	--	--

Reference Part II Attribute Tables for non-graphical information

G4010 21-07 40 10 Site Electric Distribution Systems

Description: Electrical wiring systems to distribute electrical power to on the Site. Includes Duct Banks, Pullboxes, vaults and transformers from the utility point of connection, to the building's main electric room.

Associated Masterformat Sections: 01 89 26

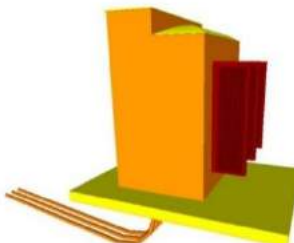
100	See G40	
200	Generic model elements in schematic layout with: approximate size, shape, and location of equipment; approximate access/code clearance requirements modeled; design performance parameters as defined in the BIMXP to be associated with model elements as non-graphic information.	
300	Modeled as design-specified size, shape, spacing, and location of raceways/ boxes/enclosures/duct banks in the power distribution system specified size, shape, spacing, and location of equipment and associated components; approximate allowances for spacing and clearances required for all specified hangers, supports and seismic control access/code clearance requirements modeled	 <p><i>212 G4010-LOD-300 Site Electric Distribution Systems</i></p>
350	Modeled as actual size, shape, spacing, and location of raceways/ boxes/enclosures/duct banks in the power distribution system; actual size, shape, spacing, and location for supports and seismic control; actual size, shape, and location/connections of equipment and support structure/pads. Actual access/code clearance requirements modeled	 <p><i>213 G4010-LOD-350 Site Electric Distribution Systems</i></p>
400	Supplementary components added to the model required for fabrication and field installation.	 <p><i>214 G4010-LOD-400 Site Electric Distribution Systems</i></p>

Reference Part II Attribute Tables for non-graphical information**G4050 21-07 40 50 Site Lighting**

Description: Luminaires, lighting equipment, ballasts, and accessories. Includes fluorescent, high intensity discharge, incandescent, mercury vapor, neon, and sodium vapor lighting. Includes Pole Mount, Building Mount and on-grade fixtures for exterior lighting.

Associated Masterformat Sections: 26 56 29

100	See G40	
200	Generic elements in schematic layout with: approximate size, shape, and location of equipment; approximate access/code clearance requirements modeled; design performance parameters as defined in the BIMXP to be associated with model elements as non-graphic information.	
300	Modeled as design-specified size, shape, spacing, and location of lighting fixtures; approximate allowances for spacing and clearances required for all specified hangers, supports and seismic control; required pole bases and footing elements; access/code clearance requirements modeled.	
350	Modeled as actual size, shape, spacing, and location of lighting fixtures; actual size, shape, spacing, and location for supports and seismic control; actual size, shape, and location/connections of equipment and support structure/pads. Actual access/code clearance requirements modeled.	
400	Supplementary components added to the model required for fabrication and field installation.	

Reference Part II Attribute Tables for non-graphical information

G50 21-07 50 Site Communications

100	Diagrammatic or schematic model elements: conceptual and/or schematic layout; design performance parameters as defined in the BIMXP to be associated with model elements as non-graphic information.	
-----	--	--

G5010 – Site Communications Systems

Description: Conduit Systems for routing of Communication trunk systems.

Associated Masterformat Sections: 33 80 00

100	See G50	
200	Generic elements in a schematic layout with: approximate size, shape, and location of equipment; approximate access/code clearance requirements modeled; design performance parameters as defined in the BIMXP to be associated with model elements as non-graphic information.	
300	Modeled as design-specified size, shape, spacing, and location of raceways, boxes, and enclosures in the power distribution system; size, shape, spacing, and location of equipment and associated components; approximate allowances for spacing and clearances required for all specified hangers, supports and seismic control; access/code clearance requirements modeled.	
350	Modeled as actual size, shape, spacing, and location of raceways, boxes, and enclosures in the power distribution system; size, shape, spacing, and location for supports and seismic control; size, shape, location, and connections of equipment and support structure or pads; floor and wall penetrations are modeled. Actual access/code clearance requirements modeled.	
400	Supplementary components added to the model required for fabrication and field installation.	

G90 21-07 90 Miscellaneous Site Construction

Associated Masterformat Sections: 01 89 29

G9010 21-07 90 10 Tunnels

Includes: Vehicular, pedestrian, and service tunnels. Includes tunnel boring, bracing and jacking work, linings and casing, grouting support systems, boring machines, and control and spoil removal systems. Includes Tunnel Construction Related Activities as appropriate.

Associated Masterformat Sections: 31 70 00 / 01 89 29

[See [Fundamental LOD Definitions](#)]

Reference Part II Attribute Tables for non-graphical information

Highway Bridges Precast Structural I Girder (Concrete)

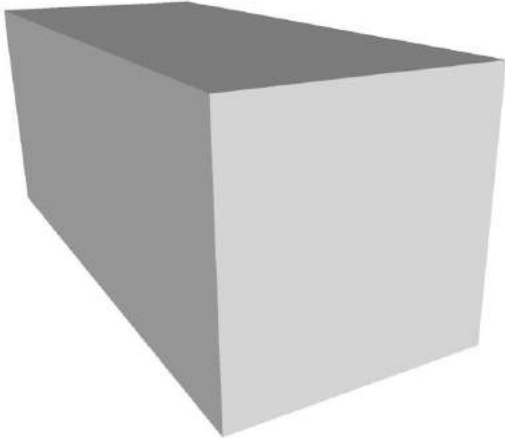
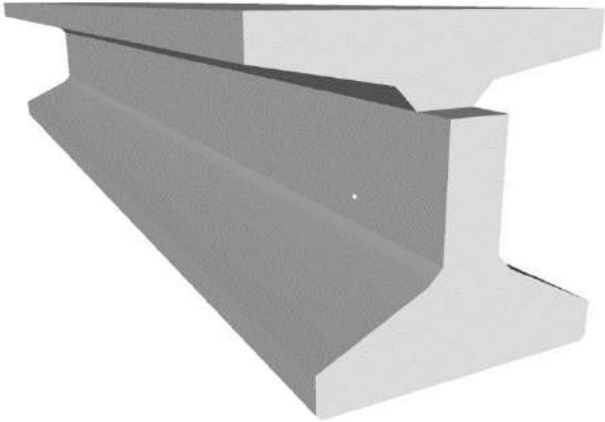
100		
200	<p>Element modeling to include:</p> <ul style="list-style-type: none"> • Type of structural concrete system • Approximate geometry (e.g. depth) of structural elements 	 <p><i>LOD 200 Highway Bridges Precast Structural I Girder (Concrete)</i></p>
300	<p>Element modeling to include:</p> <ul style="list-style-type: none"> • Specific sizes and locations of main concrete structural members modeled per defined structural grid with correct orientation • Concrete defined per spec (strength, air entrainment, aggregate size, etc.) • All sloping surfaces included in model element with exception of elements affected by manufacturer selection 	 <p><i>LOD 300 Highway Bridges Precast Structural I Girder (Concrete)</i></p>

Reference Part II Attribute Tables for non-graphical information

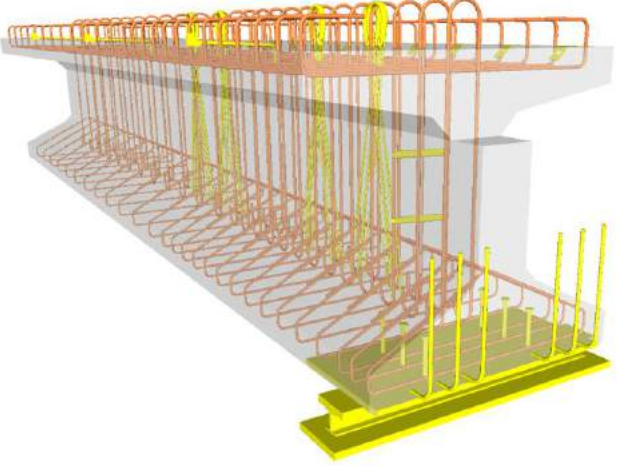
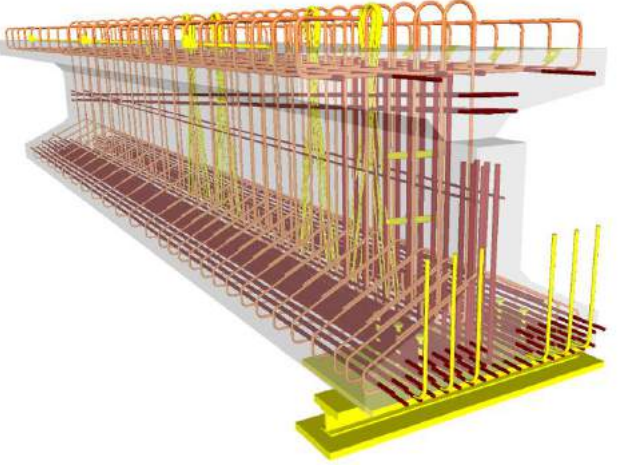
<p>350</p>	<p>Element modeling to include:</p> <ul style="list-style-type: none"> • Reinforcing Post-tension profiles and strand locations • Reinforcement called out, modeled if required by the BIMXP, typically only in congested areas • Pour joints and sequences to help identify reinforcing lap splice locations, scheduling, etc. • Expansion Joints • Lifting devices • Embeds and anchor rods • Post-tension profile and strands modeled if required by the BIMXP • Penetrations for items such as MEP • Any permanent forming or shoring components 	 <p><i>LOD 350 Highway Bridges Precast Structural I Girder (Concrete)</i></p>
<p>400</p>	<p>Element modeling to include:</p> <ul style="list-style-type: none"> • All reinforcement including post tension elements detailed and modeled • Camber, chamfer, etc. 	 <p><i>LOD 400 Highway Bridges Precast Structural I Girder (Concrete)</i></p>

Reference Part II Attribute Tables for non-graphical information

Highway Bridge Girder Steel

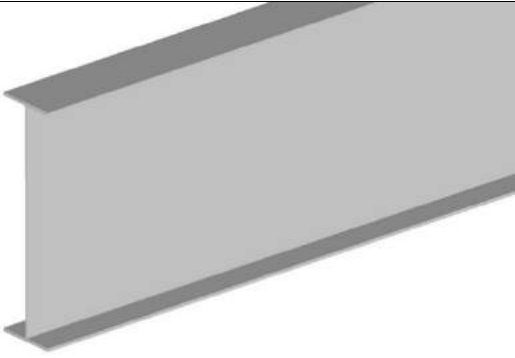
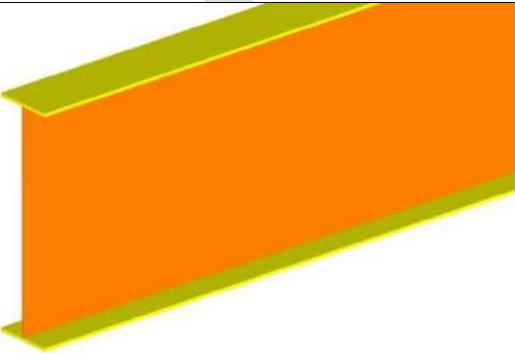
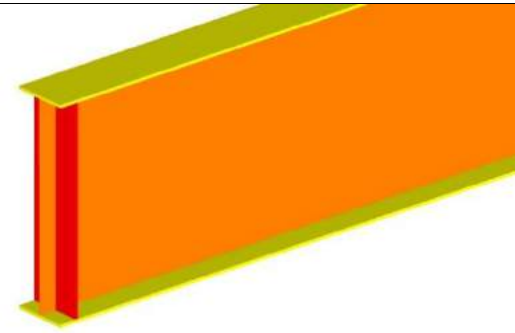
<p>200</p>	<p>Generic mass of Girder</p>	 <p><i>LOD 200 Highway Bridge Girder Steel</i></p>
<p>300</p>	<p>Element modeling to include</p> <ul style="list-style-type: none"> • Girder Depth • Web Plate Length • Flange Plate Width 	 <p><i>LOD 300 Highway Bridge Girder Steel</i></p>
<p>350</p>	<p>Element modeling to include:</p> <ul style="list-style-type: none"> • Stiffeners • Exact sloping of members • Splits between Plate Girders 	 <p><i>LOD 350 Highway Bridge Girder Steel</i></p>

Reference Part II Attribute Tables for non-graphical information

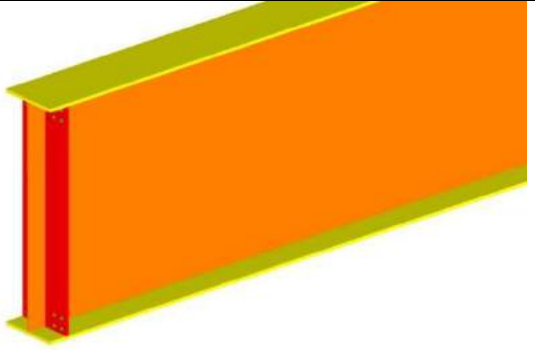
400	<p>Element modeling to include fabrication level information:</p> <ul style="list-style-type: none">• Welds• Coping of members• Washers, nuts, etc.• Grating, holes in grating• All assembly elements	 <p><i>LOD 400 Highway Bridge Girder Steel</i></p>
-----	---	--

DRAFT

Reference Part II Attribute Tables for non-graphical information

Railroad Bridges Precast Structural I Girder (Concrete)

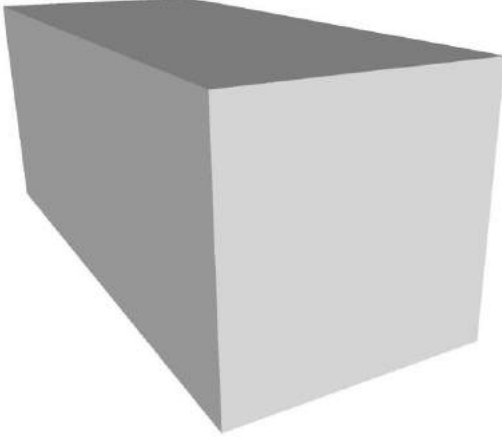
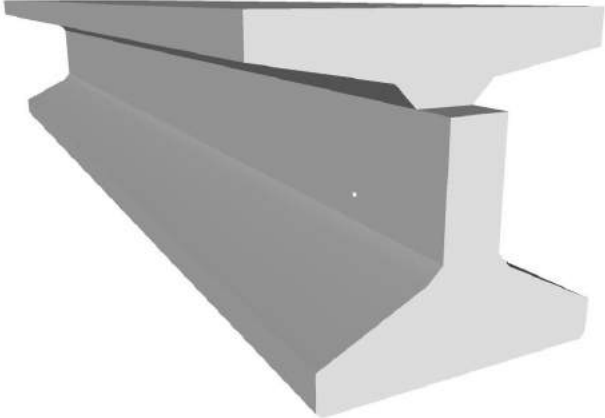
100		
200	<p>Element modeling to include:</p> <ul style="list-style-type: none"> • Type of structural concrete system • Approximate geometry (e.g. depth) of structural elements 	 <p><i>LOD 200 Railroad Bridges Precast Structural I Girder (Concrete)</i></p>
300	<p>Element modeling to include:</p> <ul style="list-style-type: none"> • Specific sizes and locations of main concrete structural members modeled per defined structural grid with correct orientation • Concrete defined per spec (strength, air entrainment, aggregate size, etc.) • All sloping surfaces included in model element with exception of elements affected by manufacturer selection 	 <p><i>LOD 300 Railroad Bridges Precast Structural I Girder (Concrete)</i></p>

Reference Part II Attribute Tables for non-graphical information

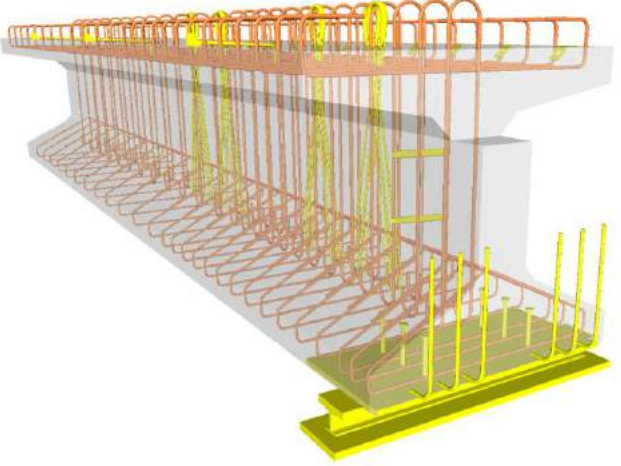
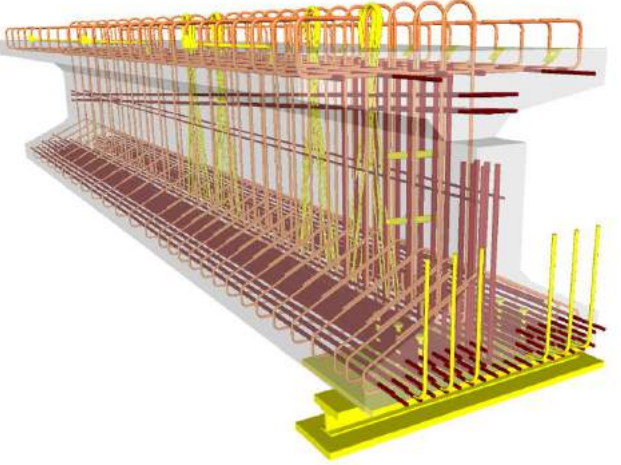
<p>350</p>	<p>Element modeling to include:</p> <ul style="list-style-type: none"> • Reinforcing Post-tension profiles and strand locations • Reinforcement called out, modeled if required by the BIMXP, typically only in congested areas • Pour joints and sequences to help identify reinforcing lap splice locations, scheduling, etc. • Expansion Joints • Lifting devices • Embeds and anchor rods • Post-tension profile and strands modeled if required by the BIMXP • Penetrations for items such as MEP • Any permanent forming or shoring components 	 <p><i>LOD 350 Railroad Bridges Precast Structural I Girder (Concrete)</i></p>
<p>400</p>	<p>Element modeling to include:</p> <ul style="list-style-type: none"> • All reinforcement including post tension elements detailed and modeled • Finishes, camber, chamfer, etc. 	 <p><i>LOD 400 Railroad Bridges Precast Structural I Girder (Concrete)</i></p>

Reference Part II Attribute Tables for non-graphical information

Railroad Bridge Girder Steel

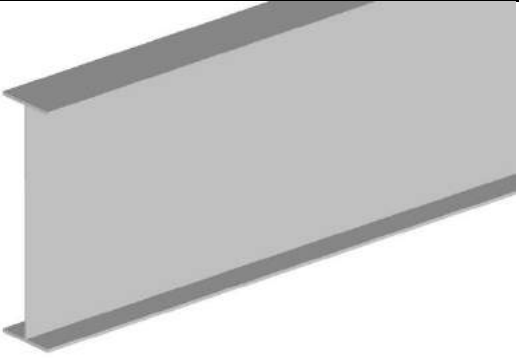
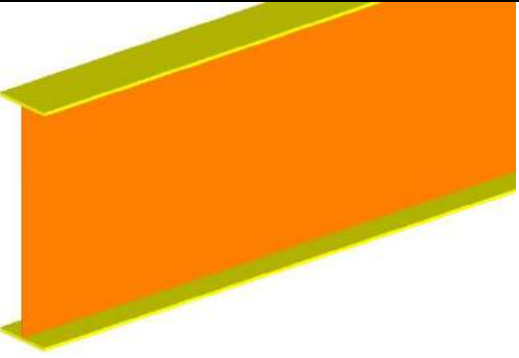
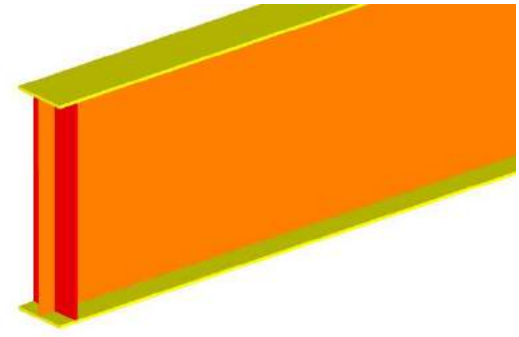
200	Generic mass of Girder	 <p><i>LOD 200 Railroad Bridge Girder Steel</i></p>
300	Element modeling to include: <ul style="list-style-type: none">• Girder Depth• Web Plate Length• Flange Plate Width	 <p><i>LOD 300 Railroad Bridge Girder Steel</i></p>
350	Element modeling to include: <ul style="list-style-type: none">• Stiffeners• Exact sloping of members• Splits between Plate Girders	 <p><i>LOD 350 Railroad Bridge Girder Steel</i></p>

Reference Part II Attribute Tables for non-graphical information

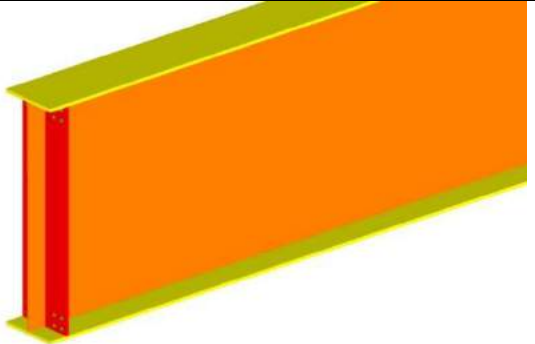
400	<p>Element modeling to include fabrication level information:</p> <ul style="list-style-type: none">• Welds• Coping of members• Washers, nuts, etc.• Grating, holes in grating• All assembly elements	 <p><i>LOD 400 Railroad Bridge Girder Steel</i></p>
-----	---	---

DRAFT

Reference Part II Attribute Tables for non-graphical information

Graphics Index

Figure 1	16
Figure 2	16
Figure 3	17
Figure 4	18
5 A1010.10-LOD-200 Wall Foundation	21
6 A1010.10-LOD-300 Wall Foundation	21
7 A1010.10-LOD-350 Wall Foundations (Shallow Foundations)	22
8 A1010.30-LOD-300 Column Foundations (Deep Foundations)	23
9 A1010.30-LOD-350 Column Foundations	24
10 A1010.30-LOD-400 Column Foundations	25
11 A1020.80-LOD-200 Grade Beams	27
12 A1020.80-LOD-300 Grade Beams	28
13 A1020.80-LOD-350 Grade Beams	28
14 A40-LOD-200 Slabs-on-Grade	30
15 A4010-LOD-300 Standard Slabs-on-Grade	31
16 A4010-LOD-350 Standard Slabs-on-Grade	31
17 A4020-LOD-300 Structural Slabs-on-Grade	32
18 A4020-LOD-350 Structural Slabs-on-Grade	32
19 B1010.10-LOD-100 Floor Structural Frame (Steel Framing Columns)	37
20 B1010.10-LOD-200 Floor Structural Frame (Steel Framing Columns)	37
21 B1010.10-LOD-300 Floor Structural Frame (Steel Framing Columns)	37
22 B1010.10-LOD-350 Floor Structural Frame (Steel Framing Columns)	37
23 B1010.10-LOD-400 Floor Structural Frame (Steel Framing Columns)	38
24 B1010.10-LOD-300 Floor Structural Frame (Steel Framing Beams)	39
25 B1010.10-LOD-350 Floor Structural Frame (Steel Framing Beams)	39
26 B1010.10-LOD-400 Floor Structural Frame (Steel Framing Beams)	39
27 B1010.100-LOD-300 Floor Structural Frame (Steel Framing Bracing Rods)	40
28 B1010.100-LOD-350 Floor Structural Frame (Steel Framing Bracing Rods)	40
29 B1010.100-LOD-400 Floor Structural Frame (Steel Framing Bracing Rods)	40
30 B1010.10-LOD-200 Floor Structural Frame (Steel Joists)	41
31 B1010.10-LOD-300 Floor Structural Frame (Steel Joists)	41
32 B1010.10-LOD-350 Floor Structural Frame (Steel Joists)	42
33 B1010.10-LOD-400 Floor Structural Frame (Steel Joists)	42
34 B1010.10-LOD-200 Floor Structural Frame (Masonry Framing)	44
35 B1010.10-LOD-300 Floor Structural Frame (Masonry Framing)	44
36 B1010.10-LOD-350 Floor Structural Frame (Masonry Framing)	44
37 B1010.10-LOD-400 Floor Structural Frame (Masonry Framing)	45
38 B1010.10-LOD-200 Floor Structural Frame (Wood Floor Trusses)	46
39 B1010.10-LOD-300 Floor Structural Frame (Wood Floor Trusses)	46
40 B1010.10-LOD-350 Floor Structural Frame (Wood Floor Trusses)	46
41 B1010.10-LOD-400 Floor Structural Frame (Wood Floor Trusses)	47
42 B1010.10-LOD 200 Precast Structural Inverted T Beam (Concrete)	48
43 B1010.10-LOD 300 Precast Structural Inverted T Beam (Concrete)	48
44 B1010.10-LOD 350 Precast Structural Inverted T Beam (Concrete)	49
45 B1010.10-LOD 400 Precast Structural Inverted T Beam (Concrete)	49
46 B1010.10- LOD 200 Precast Structural Column (Concrete)	50
47 B1010.10 - LOD 300 Precast Structural Column (Concrete)	51
48 B1010.10 - LOD 350 Precast Structural Column (Concrete)	51
49 B1010.10 - LOD 400 Precast Structural Column (Concrete)	52
50 B1010.20 – LOD 200 Precast Structural Double Tee (Concrete)	57
51 B1010.20 – LOD 300 Precast Structural Double Tee (Concrete)	57
52 B1010.20 – LOD 350 Precast Structural Double Tee (Concrete)	57
53 B1010.20 – LOD 400 Precast Structural Double Tee (Concrete)	57
54 B1080.10-LOD-200 Stair Construction	59
55 B1080.10-LOD-300 Stair Construction	60
56 B1080.10-LOD-350 Stair Construction	60
57 B1080.10-LOD-400 Stair Construction	61
58 B1080.10-LOD 200 Precast Structural Stairs (Concrete)	62
59 B1080.10-LOD 300 Precast Structural Stairs (Concrete)	62

Reference Part II Attribute Tables for non-graphical information

60 B1080.10-LOD 350 Precast Structural Stairs (Concrete)	63
61 B1080.10-LOD 400 Precast Structural Stairs (Concrete)	63
62 B1080.50-LOD-200 Stair Railings	64
63 B1080.50-LOD-300 Stair Railings	64
64 B1080.50-LOD-400 Stair Railings	64
65 B2010-LOD-200 Exterior Walls	66
66 B2010-LOD-300 Exterior Walls	66
67 B2010-LOD-350 Exterior Walls	66
68 B2010.04-LOD-200 Exterior Wall (Masonry)	67
69 B2010.04-LOD-300 Exterior Wall (Masonry)	67
70 B2010.04-LOD-350 Exterior Wall (Masonry)	68
71 B2010.04-LOD-400 Exterior Wall (Masonry)	68
72 B2010.05-LOD-200 Exterior Wall (Cold-Form Metal Framing)	69
73 B2010.05-LOD-300 Exterior Wall (Cold-Form Metal Framing)	69
74 B2010.05-LOD-350 Exterior Wall (Cold-Form Metal Framing)	70
75 B2010.05-LOD-400 Exterior Wall (Cold-Form Metal Framing)	70
76 B2010.06-LOD-200 Exterior Wall (Wood)	71
77 B2010.06-LOD-300 Exterior Wall (Wood)	71
78 B2010.06-LOD-350 Exterior Wall (Wood)	72
79 B2010.06-LOD-400 Exterior Wall (Wood)	72
80 B2010.10-LOD-100 Exterior Wall Veneer	73
81 B2010.10-LOD-200 Exterior Wall Veneer	73
82 B2010.10-LOD-300 Exterior Wall Veneer	73
83 B2010.10-LOD-350 Exterior Wall Veneer	74
84 B2010.10-LOD-400 Exterior Wall Veneer	74
85 B2010.20- LOD 350 Precast Wall (Concrete)	76
86 B2010.20- LOD 400 Precast Wall (Concrete)	77
87 B2020.30-LOD-200 Exterior Window Wall	80
88 B2020.30-LOD-300 Exterior Window Wall	80
89 B2020.30-LOD-350 Exterior Window Wall	81
90 B2020.30-LOD-400 Exterior Window Wall	82
91 C1010.04-LOD-200 Interior Wall (Masonry)	95
92 C1010.04-LOD-300 Interior Wall (Masonry)	95
93 C1010.04-LOD-350 Interior Wall (Masonry)	95
94 C1010.04-LOD-400 Interior Wall (Masonry)	96
95 C1010.05-LOD-200 Interior Wall (Cold-Form Metal Framing)	97
96 C1010.05-LOD-300 Interior Wall (Cold-Form Metal Framing)	97
97 C1010.05-LOD-350 Interior Wall (Cold-Form Metal Framing)	98
98 C1010.05-LOD-400 Interior Wall (Cold-Form Metal Framing)	98
99 C1010.06-LOD-200 Interior Wall (Wood)	99
100 C1010.06-LOD-300 Interior Wall (Wood)	99
101 C1010.06-LOD-350 Interior Wall (Wood)	100
102 C1010.06-LOD-400 Interior Wall (Wood)	100
103 D1050.70-LOD-100 Pneumatic Tube Systems	119
104 D1050.70-LOD-200 Pneumatic Tube Systems	119
105 D1050.70-LOD-300 Pneumatic Tube Systems	119
106 D1050.70-LOD-350 Pneumatic Tube Systems	119
107 D1050.70-LOD-400 Pneumatic Tube Systems	120
108 D2010.10-LOD-200 Facility Potable-Water Storage Tanks	122
109 D2010.10-LOD-300 Facility Potable-Water Storage Tanks	122
110 D2010.10-LOD-350 Facility Potable-Water Storage Tanks	122
111 D2010.10-LOD-400 Facility Potable-Water Storage Tanks	122
112 D2010.20-LOD-100 Domestic Water Equipment	123
113 D2010.20-LOD-200 Domestic Water Equipment	123
114 D2010.20-LOD-300 Domestic Water Equipment	123
115 D2010.20-LOD-350 Domestic Water Equipment	123
116 D2010.20-LOD-400 Domestic Water Equipment	123
117 D2010.40-LOD-200 Domestic Water Piping	124
118 D2010.40-LOD-300 Domestic Water Piping	124
119 D2010.40-LOD-350 Domestic Water Piping	124
120 D2010.40-LOD-400 Domestic Water Piping	124
121 D2010.60-LOD-200 Plumbing Fixtures	125

Reference Part II Attribute Tables for non-graphical information

122	D2010.60-LOD-200 Plumbing Fixtures.....	125
123	D2010.60-LOD-350 Plumbing Fixtures.....	125
124	D2010.60-LOD-400 Plumbing Fixtures.....	125
125	D2020.10-LOD-200 Sanitary Sewerage Equipment.....	127
126	D2020.10-LOD-300 Sanitary Sewerage Equipment.....	127
127	D2020.10-LOD-350 Sanitary Sewerage Equipment.....	127
128	D2020.10-LOD-400 Sanitary Sewerage Equipment.....	127
129	D2020.30-LOD-200 Sanitary Sewerage Piping.....	128
130	D2020.30-LOD-300 Sanitary Sewerage Piping.....	128
131	D2020.30-LOD-350 Sanitary Sewerage Piping.....	128
132	D2020.30-LOD-400 Sanitary Sewerage Piping.....	128
133	D2030.10-LOD-200 Stormwater Drainage Equipment.....	130
134	D2030.10-LOD-300 Stormwater Drainage Equipment.....	130
135	D2030.10-LOD-350 Stormwater Drainage Equipment.....	130
136	D2030.10-LOD-400 Stormwater Drainage Equipment.....	130
137	D2030.20-LOD-200 Stormwater Drainage Piping.....	131
138	D2030.20-LOD-300 Stormwater Drainage Piping.....	131
139	D2030.20-LOD-350 Stormwater Drainage Piping.....	131
140	D2030.20-LOD-400 Stormwater Drainage Piping.....	132
141	D2030.30-LOD-200 Facility Stormwater Drains.....	133
142	D2030.30-LOD-300 Facility Stormwater Drains.....	133
143	D2030.30-LOD-350 Facility Stormwater Drains.....	133
144	D2030.30-LOD-400 Facility Stormwater Drains.....	133
145	D2060.10-LOD-200 Compressed-Air Systems.....	135
146	D2060.10-LOD-300 Compressed-Air Systems.....	135
147	D2060.10-LOD-350 Compressed-Air Systems.....	135
148	D2060.10-LOD-400 Compressed-Air Systems.....	135
149	D3010.10-200 Fuel Piping.....	138
150	D3010.10-300 Fuel Piping.....	138
151	D3010.10-350 Fuel Piping.....	138
152	D3010.10-400 Fuel Piping.....	139
153	D3010.50-LOD-200 Fuel Storage Tanks.....	140
154	D3010.50-LOD-300 Fuel Storage Tanks.....	140
155	D3010.50-LOD-350 Fuel Storage Tanks.....	140
156	D3010.50-LOD-400 Fuel Storage Tanks.....	140
157	D3020.10-LOD-200 Heat Generation.....	142
158	D3020.10-LOD-300 Heat Generation.....	142
159	D3020.10-LOD-350 Heat Generation.....	142
160	D3020.10-LOD-400 Heat Generation.....	142
161	D3030.10-LOD-200 Central Cooling.....	144
162	D3030.10-LOD-300 Central Cooling.....	144
163	D3030.10-LOD-350 Central Cooling.....	144
164	D3030.10-LOD-400 Central Cooling.....	144
165	D3030.30-LOD-200 Evaporative Air-Cooling.....	145
166	D3030.30-LOD-300 Evaporative Air-Cooling.....	145
167	D3030.30-LOD-350 Evaporative Air-Cooling.....	145
168	D3030.30-LOD-400 Evaporative Air-Cooling.....	145
169	D3050.10-LOD-200 Facility Hydronic distribution.....	147
170	D3050.10-LOD-300 Facility Hydronic Distribution.....	147
171	D3050.10-LOD-350 Facility Hydronic Distribution.....	147
172	D3050.10-LOD-400 Facility Hydronic Distribution.....	148
173	D3060.10-LOD-200 Supply Air.....	150
174	D3060.10-LOD-300 Supply Air.....	150
175	D3060.10-LOD-350 Supply Air.....	150
176	D3060.10-LOD-400 Supply Air.....	151
177	D3060.30-LOD-200 Exhaust Air.....	152
178	D3060.30-LOD-300 Exhaust Air.....	152
179	D3060.30-LOD-350 Exhaust Air.....	152
180	D3060.30-LOD-400 Exhaust Air.....	152
181	D4010.10-LOD-200 Water-Based Fire-Suppression.....	155
182	D4010.10-LOD-300 Water-Based Fire-Suppression.....	155
183	D4010.10-LOD-350 Water-Based Fire-Suppression.....	155

Reference Part II Attribute Tables for non-graphical information

184 D4010.10-LOD-400 Water-Based Fire-Suppression	155
185 D5010.10-LOD-200 Packaged Generator Assemblies	159
186 D5010.10-LOD-300 Packaged Generator Assemblies	159
187 D5010.10-LOD-350 Packaged Generator Assemblies	159
188 D5010.10-LOD-400 Packaged Generator Assemblies	159
189 D5020.10-LOD-300 Electrical Service Entrance	161
190 D5020.10-LOD-350 Electrical Service Entrance	161
191 D5020.10-LOD-400 Electrical Service Entrance	161
192 D5020.30-LOD-300 Power Distribution	162
193 D5020.30-LOD-350 Power Distribution	162
194 D5020.30-LOD-400 Power Distribution	162
195 D5030.10-LOD-300 Branch Wiring System	164
196 D5030.10-LOD-350 Branch Wiring System	164
197 D5040.50-LOD-300 Lighting Fixtures	166
198 D5040.50-LOD-350 Lighting Fixtures	166
199 F1020.40-LOD 100 Metal Building Systems	178
200 F1020.40-LOD 200 Metal Building Systems - Primary Framing	179
201 F1020.40-LOD 300 Metal Building Systems - Primary Framing	179
202 F1020.40-LOD 350 Metal Building Systems - Primary Framing	180
203 F1020.40-LOD 400 Metal Building Systems - Primary Framing	181
204 F1020.40-LOD 200 Metal Building Systems - Secondary Framing	182
205 F1020.40-LOD 300 Metal Building Systems - Secondary Framing	182
206 F1020.40-LOD 350 Metal Building Systems- Secondary Framing	183
207 F1020.40-LOD 400 Metal Building Systems - Secondary Framing	183
208 F1020.40-LOD 200 Metal Building Systems –Cladding and Exterior Trim	184
209 F1020.40-LOD 300 Metal Building Systems –Cladding and Exterior Trim	184
210 F1020.40-LOD 350 Metal Building Systems –Cladding and Exterior Trim	185
211 G10-LOD-100 Site Preparation	187
212 G4010-LOD-300 Site Electric Distribution Systems	192
213 G4010-LOD-350 Site Electric Distribution Systems	192
214 G4010-LOD-400 Site Electric Distribution Systems	192

Appendix

The appendix section contains content that is developed in collaboration with industry organizations, leading expert practitioners, and feedback from committees following the issue of the October 2015. They are being released in the Appendix of this edition of the LOD Specification for public comment and use. They are proposed for the main body of the next submission of the LOD Specification.

Reference Part II Attribute Tables for non-graphical information

Origins: Basis for all LOD

Clearly Define the Local X,Y,Z Origin

This is the simplest rule to implement and sadly the most common and costly single item that goes unaddressed in ignorance on projects. The project general notes of the design drawings and specification should clearly define the local relative Building X, Y, Z coordinates that other trades will use in construction that are coordinated with the structural model. It is recommended to define the X,Y coordinates of the origin (Revit Project Internal 0,0) relative to the Southwest most column grid intersection with a South and West offset of 10, 100 or 1000 feet depending on the project size. The Southwest column intersection is chosen so the structure is in a positive X-Y coordinate system. The offsets of 10, 100 or 1000 feet South and West of the origin are so that any portions of the building that extend South or West of the project origin grid intersections will also be within a positive X-Y coordinate system. The Z elevation should be defined as 0, 100' or absolute elevation depending on firm preference. It is common to use a relative 100' elevation. Plan North is established as being in the positive Y direction.

These rules above form the basis of the project's "local" relative Building coordinate system that becomes part of the legal definition in contracts related to the model and references to LOD. This process aids linking the structural model to third party applications that are based on traditional CAD coordinate systems. A benefit of defining the local relative origin early and stating it in the project's general notes is other models that are developed for shop drawings from the construction documents have a point of reference to follow when they are submitted for review. This local relative building coordinate system is also tied back to the civil engineers' state plane coordinate system referred to as the Civil coordinates in Civil 3D. Larger products will also have a Campus coordinate system normally near the Southwest corner of the project site. There can also be an Object coordinate system used for items such as equipment models. This Object coordinate system is typically referenced relative to the Local Building coordinate system in the form of a grid line offset and floor elevation offset. The Civil coordinate system defined by the state plane absolute coordinate system will then have a set relationship with the structural local Building coordinate system of an X, Y, and Z offset and a Z-axis rotation. Using this set relationship between the Civil absolute and relative Building coordinate system, all federated project models can be easily converted to absolute or relative systems depending on the owner's preference in their facility management models. Ideally, the owner will have a clearly written documentation in the BIM Execution Plan that accurately defines the relationship between Object, Building, Campus and Civil coordinate systems.

In summary these 4 coordinate systems are:

Object: relative system that defines items such as assemblies and equipment in the structure. For example, the Air Handler Unit will have a relative Object coordinate that reference the Local Building coordinate which defines the mechanical room it resides in.

Building, Local: relative building coordinate system normally defined so that the entire structure is in positive point coordinates. For structure, this should be defined in the construction documents.

Campus, Site: relative coordinate system of the building's site defined so that the entire site is in positive point coordinates.

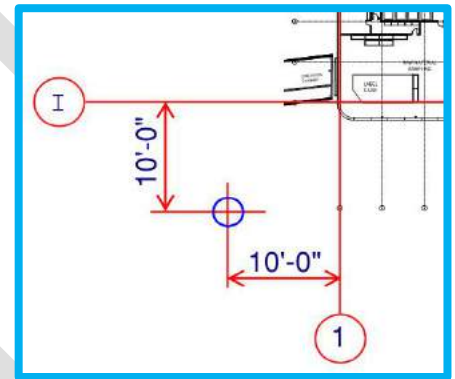
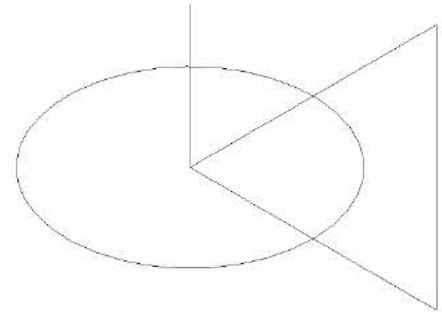

CAMPUS COORDINATES

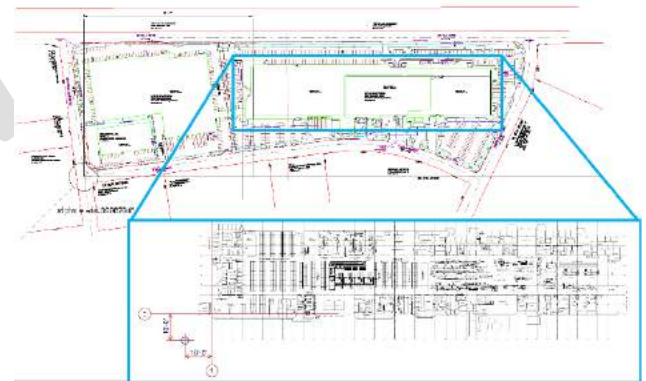

LOCAL BUILDING COORDINATES

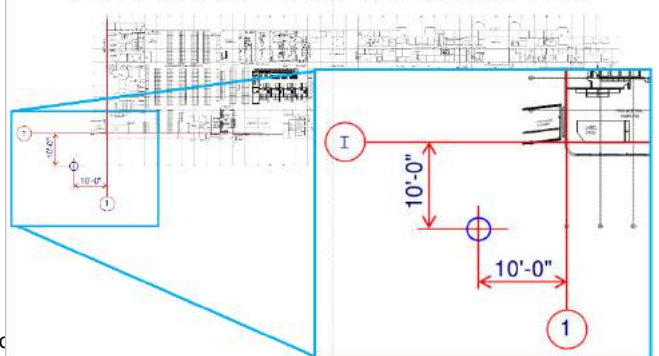

Reference Part II Attribute Tables for non-graphical information

Civil (State Plane): Absolute coordinate system with Northing and Easting used by surveyors and civil engineers. This is also used by owners tying in their BIM to GIS applications for example.

Steps and Jobs to be done:

Structural engineer needs to be able to set the LOD of the origin of the project with the Architect at the start of the DD phase of the project. This needs to be coordinated with the civil engineer and site surveyors state plane coordinates. Following this, any manufacture will reference the building coordinates for the placing of their content.

SITE PLAN & CAMPUS COORDINATES

